



Product size

PRODUCT INFORMATION

Packing list in	Quantity
Microwave Sensor Lamp	1X
 Φ6 Plastic Expand	3X
 4x30 Screw	3X

This product appearance is concise, easy, use range (sitting room, bedroom, study, corridor, etc), function of advanced internal microwave sensors try products humanized control.

The microwave sensors is according to the microwave doppler effect <the basic principle of radar> , it can be widely used in as automatic control switch, the security system, and automatic video control system of ATM, as well as other automatic induction control area. The detection way has the below advantages compared with other as follows: 1. Non-contact detection, 2. Suitable for bad environment, immune to temperature, humidity, noise, air, dust, light...3.RF interference ability, 4.Transmission power only 0.3 mW, It will not harm the human body. Simple installation+ easy wiring. We use appropriate micro processing integrator, not only for high sensitivity and wide range of detection, and on very reliable work, error rate is extremely low, It can stable working on the temperature range: - 15 ~ + 70 degrees.

Warranty against defects is 1 year.

IP 44



Use high quality White frosted glass chimney.Strengthen the flexible refraction of light.And its function of anti-ultraviolet makes the shade not easy to turn yellow and be broken.

NAME OF EACH PART

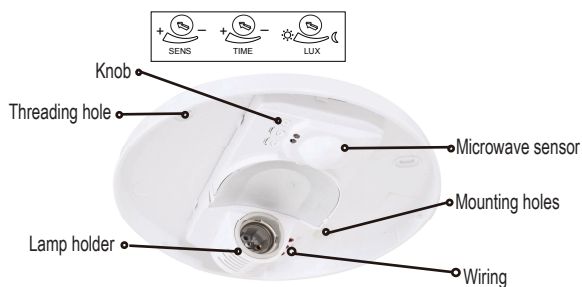

Lamps and lanterns base



White frosted glass chimney

SPECIFICATIONS

Power source: 100-130V/AC
 220-240V/AC

Power frequency: 50/60Hz

HF system: : 5.8GHz CW electric wave,
 ISM band

Transmission power: <0.3mW

Rated load: 60W Max/E27

Detection angle: 360°

Detection range: 3-9m (radii.) (adjustable)

Time setting: 8sec to 12min (adjustable)

Light-control: 2-2000LUX (adjustable)

Standby power: <0.9W

Luminou flux: 450lm

Net weight: about1.332kg

Installation: indoor ceiling mount

INDUCTION RANGE

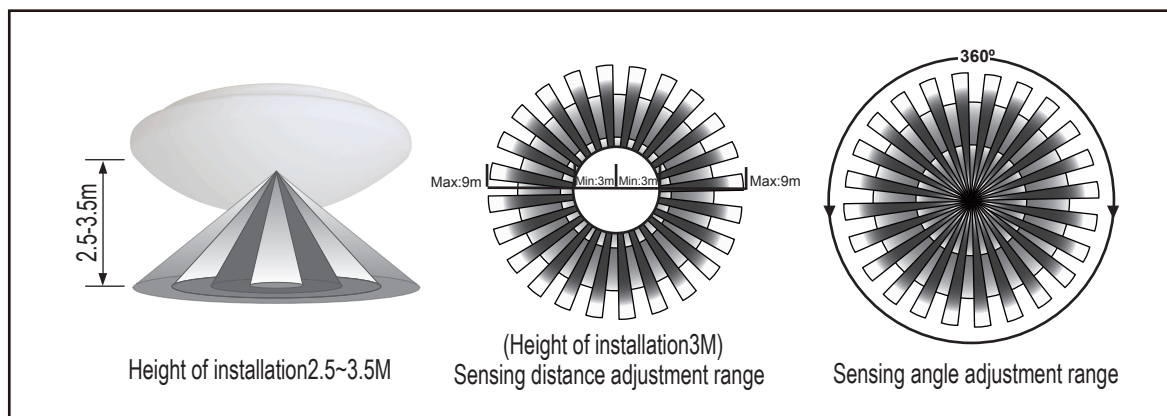

PROCEDURE OF INSTALLATION



Warning!

1. Please keep it away from the children.
2. Please avoid fire/high temperature/damp places for installation.
3. Please confirm when shut off the power cord access.

Note: Please bring the following tools



Pencil

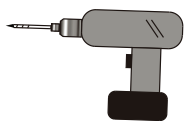

Electric drill

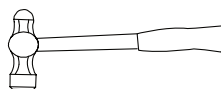

Hammer



Screwdriver

- Step1 Rotating chimney down chimney(as follow: the product should be separated into two parts as A and B)

NOTE: Chimney is fragile, please don't take too much force



A



B

Fig.1

- Step2 Turn the knobs to the ideal conditions (as Fig.2)

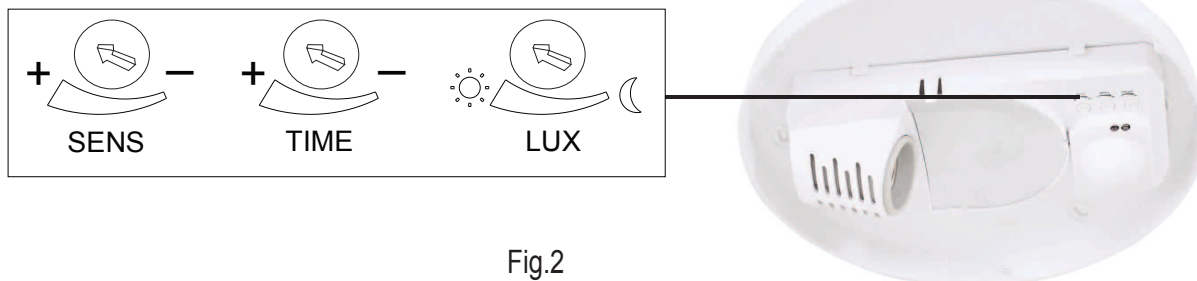
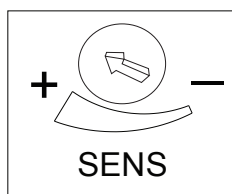

Fig.2

Reach setting (sensitivity)



Reach is the term used to describe the radii of the more or less circular detection zone produced on the ground after mounting the sensor light at a height of 2.5m, turn the reach control fully anticlockwise to select minimum reach (approx.3m radii), and fully clockwise to select maximum reach (approx. 9m radii).

NOTE: the above detection distance is gained in the case of a person who is between 1.6m~1.7m tall with middle figure and moves at a speed of 1.0~1.5m/sec. if person's stature, figure and moving speed change, the detection distance will also change.

Time setting

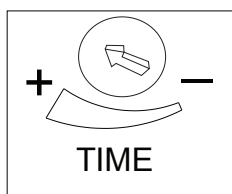

The light can be set to stay ON for any period of time between approx. 8sec(turn fully anticlockwise) and a maximum of 12min(turn fully clockwise). Any movement detected before this time elapse will re-start the timer. It is recommended to select the shortest time for adjusting the detection zone and for performing the walk test.

NOTE: after the light switches OFF, it takes approx. 1sec before it is able to start detecting movement again. The light will only switch on in response to movement once this period has elapsed.

Light-control setting

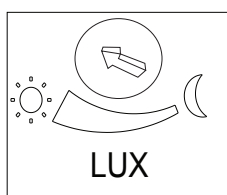

The chosen light response threshold can be infinitely from approx. 2-2000lux. Turn it fully anti-clockwise to select dusk- to-dawn operation at about 2 lux. Turn it fully clockwise to select daylight operation at about 2000lux. The knob must be turned fully clockwise when adjusting the detection zone and performing the walk test in daylight.

- Step3 Put the base of the product on the ceiling to make the drilling mark (as Fig.3)

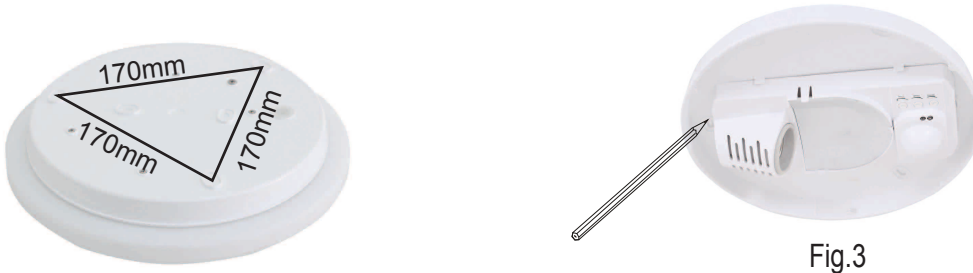

Fig.3

- Step4 Install the product on the place where you marked (as Fig.4)
- Step5 Knock the plastic expansion screw into the hole which you drill (as Fig.5)

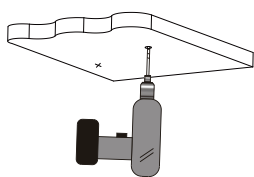

Fig.4

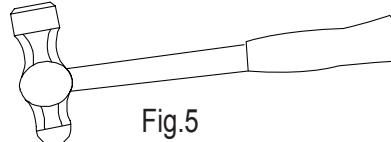
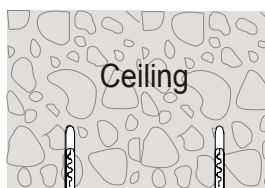
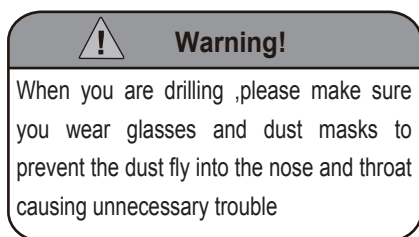

Fig.5

- Step6 Put the power line through the line hole to connect on the wiring (as Fig.6)

Warning! Please confirm when shut off the power cord access.

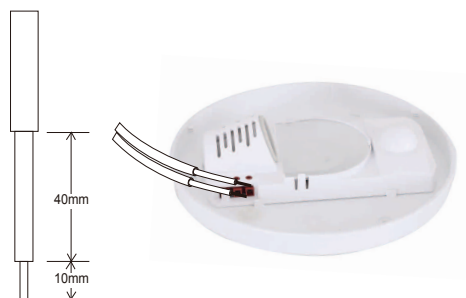
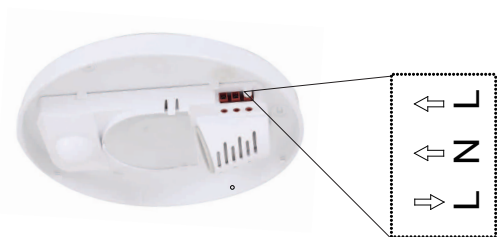

Fig.6

- Step7 Fix the base of the product on the selected place with the screws (as Fig.7)

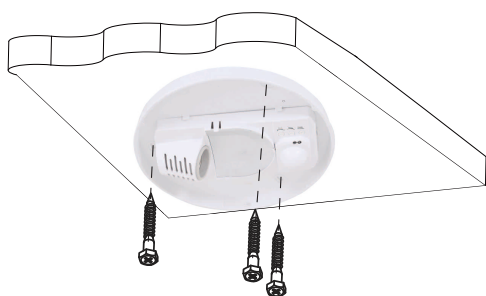
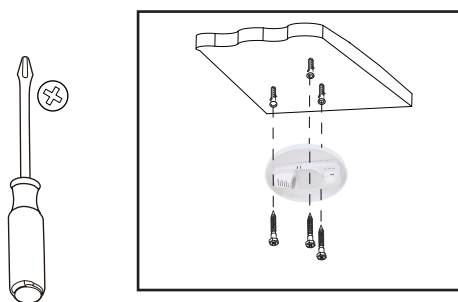
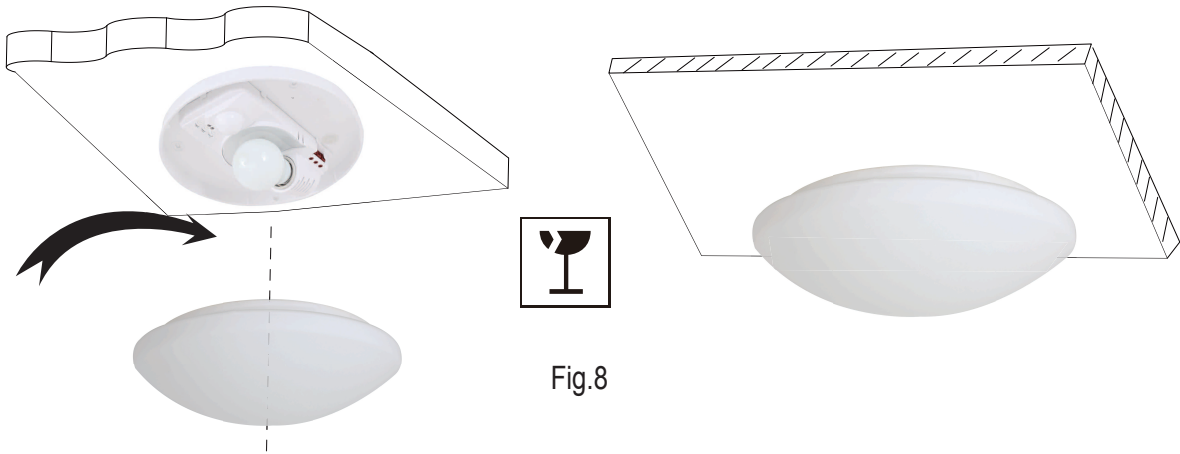

Fig.7



Concrete ceiling

- Step8 Will rotate, cover chimney on base (as Fig.8)



Troubleshooting

Malfunction	Cause	Remedy
Sensorlight will not switch ON	• wrong light-control setting selected	• Adjust setting
	• bulb faulty	• Change bulb
	• mains switch OFF	• Switch ON
Sensor light will not switch OFF	• continuous movement in the detection zone	• check zone setting
Sensorlight switches on without any identifiable movement	• light not mounted for detecting movement reliably	• securely mount enclosure
	• movement occurred, but not identified by the sensor(movement behind wall, movement of a small object in immediate lamp vicinity etc.)	• Check zone setting
Sensorlight does not switch ON despite movement	• rapid movements are being suppressed to minimize malfunctioning or the detection zone you have set is too small	• Check zone setting

NOTE: the high-frequency output of this sensor is <math><0.3\text{mW}</math>- that is just one 3300th of the transmission power of a mobile phone or the output of a microwave oven.

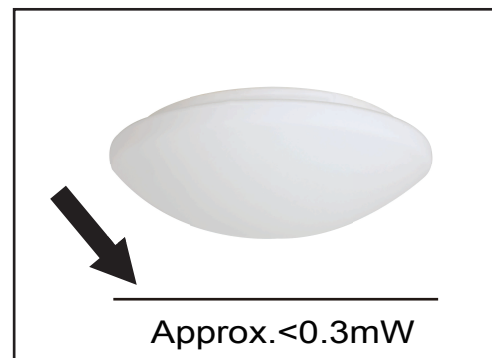

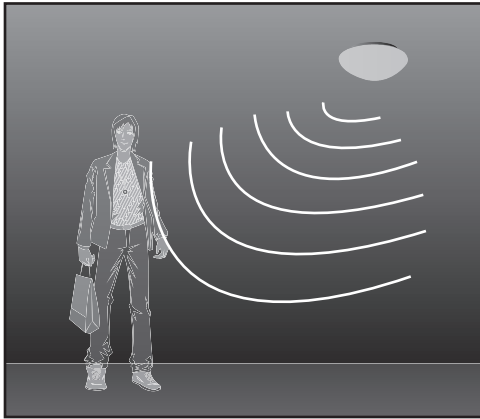

! Warning!

Please confirm with profession installation.

Please cut off power supply before installation and removal operations.

Make sure that you have cut off the power for safety purposes.

Improper operation caused losses, the manufacturer does not undertake any responsibility.

Maaletooja: Elit OÜ

Telefon: +372 58 147 907

www.elit.ee

e-post: elit@elit.ee