

# CP series CP1H CPU Unit

## CP1H-X□□D□-□/CP1H-Y□□D□-□

### CP1H-XA□□D□-□

## 4 Axis Position Control and Comprehensive Programmable Controller

- The CP1H-X with pulse outputs for 4 axes.
- The CP1H-Y with 1-MHz pulse I/O.
- The CP1H-XA with pulse outputs for 4 axes and built-in analog I/O.



## Features

- Pulse output for 4 axes. Advanced power for high-precision positioning control.
- High-speed counters. Differential phases for 4 axes.  
Easily handles multi-axis control with a single unit.
- Eight interrupt inputs are built in. Faster processing of approximately 500 instructions speeds up the entire system.
- Serial communications. Two ports. Select Option Boards for either RS-232C or RS-485 communications.
- Ethernet Communications. Enabled by using an Option Board. Two ports can be used as an Ethernet port to perform. Ethernet communications between the CP1H and a host computer.
- Built-in Analog I/O. XA CPU Units provide 4 input words and 2 output words.
- USB Peripheral Port. Another standard feature.
- The structured text (ST) language. Makes math operations even easier.
- Can be used for the CP1W series and CJ series Unit. The extendibility of it is preeminently good.
- LCD displays and settings. Enabled using Option Board.

# CP1H

## Model Number Structure

■ Model Number Legend (Not all models that can be represented with the model number legend can necessarily be produced.)

**CP1H-□□D□-□**  
 (1) (2) (3) (4)

- |  |  |
|--|--|
| <p>1. Class<br/>         X : Basic model<br/>         XA : Built-in analog I/O terminals<br/>         Y : Dedicated pulse I/O terminals</p> <p>2. Number of Built-In number I/O points<br/>         40 : 40 I/O points<br/>         20 : 20 I/O points</p> | <p>3. Output classification<br/>         R : Relay output<br/>         T : Transistor Output (sinking)<br/>         T1 : Transistor Output (sourcing)</p> <p>4. Power supply<br/>         A : AC<br/>         D : DC</p> |
|--|--|

## Ordering Information

### Applicable standards

Refer to the OMRON website ([www.ia.omron.com](http://www.ia.omron.com)) or ask your OMRON representative for the most recent applicable standards for each model.



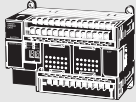
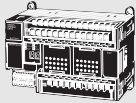
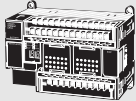



### ■ CPU Units

CPU Unit	Specifications					Model
	CPU type	Power supply	Output method	Inputs	Outputs	
 <b>CP1H-X CPU Units</b>	<b>Memory capacity: 20K steps</b> <b>High-speed counters: 100 kHz, 4 axes</b> <b>Pulse outputs: 100 kHz, 4 axes</b> (Models with transistor outputs only)	AC power supply	Relay output	24	16	<b>CP1H-X40DR-A</b>
		DC power supply	Transistor output (sinking)			<b>CP1H-X40DT-D</b>
			Transistor output (sourcing)			<b>CP1H-X40DT1-D</b>
 <b>CP1H-XA CPU Units</b>	<b>Memory capacity: 20K steps</b> <b>High-speed counters: 100 kHz, 4 axes</b> <b>Pulse outputs: 100 kHz, 4 axes</b> (Models with transistor outputs only) <b>Analog inputs: 4</b> <b>Analog outputs: 2</b>	AC power supply	Relay output	24	16	<b>CP1H-XA40DR-A</b>
		DC power supply	Transistor output (sinking)			<b>CP1H-XA40DT-D</b>
			Transistor output (sourcing)			<b>CP1H-XA40DT1-D</b>
 <b>CP1H-Y CPU Units</b>	<b>Memory capacity: 20K steps</b> <b>High-speed counters: 1 MHz, 2 axes</b> <b>100 kHz, 2 axes</b> <b>Pulse outputs: 1 MHz, 2 axes</b> <b>100 kHz, 2 axes</b>	DC power supply	Transistor output (sinking)	12 + line-driver input, 2 axes	8 + line-driver output, 2 axes	<b>CP1H-Y20DT-D</b>

Note: 1. CP1H PLCs are supported by CX-Programmer version 6.1 or higher.

2. Purchase a separately sold Option Unit if you will use RS-232C, RS-422A/485, Ethernet, or LCD.

### ■ Options for CPU Units

Name	Specifications	Model
<b>RS-232C Option Board</b> 	Can be mounted in either CPU Unit Option Board slot 1 or 2.	<b>CP1W-CIF01</b>
<b>RS-422A/485 Option Board</b> 		<b>CP1W-CIF11</b>
<b>RS-422A/485 (Isolated-type) Option Board</b> 		<b>CP1W-CIF12-V1</b>
<b>Ethernet Option Board</b> 	Can be mounted in either CPU Unit Option Board slot 1 or 2. *	<b>CP1W-CIF41</b>
<b>LCD Option Board</b> 	Can be mounted only in the CPU Unit Option Board slot 1.	<b>CP1W-DAM01</b>
<b>Memory Cassette</b> 	Can be used for backing up programs or auto-booting.	<b>CP1W-ME05M</b>

\* When using CP1W-CIF41 Ver.1.0, one Ethernet port can be added.

Windows are either registered trademarks or trademarks of Microsoft Corporation in the United States and/or other countries.

Other company names and product names in this document are the trademarks or registered trademarks of their respective companies.

## ■ Programming Devices

Name	Specifications		Model	
	Number of licenses	Media		
<b>FA Integrated Tool Package CX-One Lite Version 4.□</b>	CX-One Lite is a subset of the complete CX-One package that provides only the Support Software required for micro PLC applications. CX-One Lite runs on the following OS. OS: Windows XP (Service Pack 3 or higher, 32-bit version) / Windows Vista (32-bit/64-bit version) / Windows 7 (32-bit/64-bit version) / Windows 8 (32-bit/64-bit version) / Windows 8.1 (32-bit/64-bit version) / Windows 10 (32-bit/64-bit version)  CX-One Lite Ver. 4.□ includes Micro PLC Edition CX-Programmer Ver. 9.□.	1 license	DVD	<b>CXONE-LT01C-V4</b>
<b>FA Integrated Tool Package CX-One Ver. 4.□</b>	CX-One is a package that integrates the Support Software for OMRON PLCs and components. CX-One runs on the following OS. OS: Windows XP (Service Pack 3 or higher, 32-bit version) / Windows Vista (32-bit/64-bit version) / Windows 7 (32-bit/64-bit version) / Windows 8 (32-bit/64-bit version) / Windows 8.1 (32-bit/64-bit version) / Windows 10 (32-bit/64-bit version)  CX-One Ver. 4.□ includes CX-Programmer Ver. 9.□.	1 license (See note 3.)	DVD	<b>CXONE-AL01D-V4</b>
<b>Programming Device Connecting Cable for CP1W-CIF01 RS-232C Option Board (See note 4.)</b>	Connects Personal Computers, D-Sub 9-pin (Length: 2.0 m)	For anti-static connectors		<b>XW2Z-200S-CV</b>
	Connects Personal Computers, D-Sub 9-pin (Length: 5.0 m)			<b>XW2Z-500S-CV</b>
	Connects Personal Computers, D-Sub 9-pin (Length: 2.0 m)			<b>XW2Z-200S-V</b>
	Connects Personal Computers, D-Sub 9-pin (Length: 5.0 m)			<b>XW2Z-500S-V</b>

**Note:** 1. CP1H PLCs are supported by CX-Programmer version 6.1 or higher.

Update The CX-Programmer version automatically from the website using CX-Programmer version 7.0 (included with CX-One version 2.0).

2. The CX-One and CX-One Lite cannot be simultaneously installed on the same computer.

3. Multi licenses (3, 10, 30, or 50 licenses) and DVD media without licenses are also available for the CX-One.

4. Cannot be used with a peripheral USB port.







To connect to a Personal Computers via a peripheral USB port, use commercially-available USB cable (A or B type, male).

The following tables lists the Support Software that can be installed from CX-One

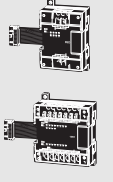
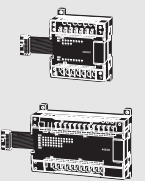
Support Software in CX-One		CX-One Lite Ver.4.□	CX-One Ver.4.□	Support Software in CX-One		CX-One Lite Ver.4.□	CX-One Ver.4.□
Micro PLC Edition CX-Programmer	Ver.9.□	Yes	No	CX-Drive	Ver.1.□	Yes	Yes
CX-Programmer	Ver.9.□	No	Yes	CX-Process Tool	Ver.5.□	No	Yes
CX-Integrator	Ver.2.□	Yes	Yes	Faceplate Auto-Builder for NS	Ver.3.□	No	Yes
Switch Box Utility	Ver.1.□	Yes	Yes	CX-Designer	Ver.3.□	Yes	Yes
CX-Protocol	Ver.1.□	No	Yes	NV-Designer	Ver.1.□	Yes	Yes
CX-Simulator	Ver.1.□	Yes	Yes	CX-Thermo	Ver.4.□	Yes	Yes
CX-Position	Ver.2.□	No	Yes	CX-ConfiguratorFDT	Ver.1.□	Yes	Yes
CX-Motion-NCF	Ver.1.□	No	Yes	CX-FLnet	Ver.1.□	No	Yes
CX-Motion-MCH	Ver.2.□	No	Yes	Network Configurator	Ver.3.□	Yes	Yes
CX-Motion	Ver.2.□	No	Yes	CX-Server	Ver.4.□	Yes	Yes

**Note:** For details, refer to the CX-One Catalog (Cat. No: R134).

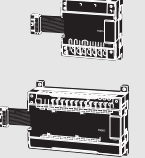
## ■ Expansion Units

Product name	Inputs	Outputs	Output type		Model
<b>Input Unit</b>	8	--	24 VDC Input		CP1W-8ED
<b>Output Units</b> 	--	8	Relay		CP1W-8ER
			Transistor (sinking)		CP1W-8ET
			Transistor (sourcing)		CP1W-8ET1
	--	16	Relay		CP1W-16ER
			Transistor (sinking)		CP1W-16ET
			Transistor (sourcing)		CP1W-16ET1
	--	32	Relay		CP1W-32ER
			Transistor (sinking)		CP1W-32ET
			Transistor (sourcing)		CP1W-32ET1
<b>I/O Units</b> 	12	8	Relay		CP1W-20EDR1
			Transistor (sinking)		CP1W-20EDT
			Transistor (sourcing)		CP1W-20EDT1
	24	16	Relay		CP1W-40EDR
			Transistor (sinking)		CP1W-40EDT
Transistor (sourcing)			CP1W-40EDT1		
<b>Analog Input Unit</b> 	4CH	--	Input range: 0 to 5 V, 1 to 5 V, 0 to 10 V, ±10 V, 0 to 20 mA, or 4 to 20 mA.	Resolution: 1/6000	CP1W-AD041
				Resolution: 1/12000	CP1W-AD042
<b>Analog Output Unit</b> 	--	2CH	Output range: 1 to 5 V, 0 to 10 V, ±10 V, 0 to 20 mA, or 4 to 20 mA.	Resolution: 1/6000	CP1W-DA021
				--	4CH
			Resolution: 1/12000		
<b>Analog I/O Unit</b> 	4CH	4CH	Input range: 0 to 5 V, 1 to 5 V, 0 to 10 V, ±10 V, 0 to 20 mA, or 4 to 20 mA. Output range: 1 to 5 V, 0 to 10 V, ±10 V, 0 to 20 mA, or 4 to 20 mA.	Resolution: 1/12000	CP1W-MAD44
	4CH	2CH		Resolution: 1/12000	CP1W-MAD42
	2CH	1CH		Resolution: 1/6000	CP1W-MAD11
<b>Temperature Sensor Unit</b> 	2CH	--	Sensor type: Thermocouple (J or K)		CP1W-TS001
	4CH	--	Sensor type: Thermocouple (J or K)		CP1W-TS002
	2CH	--	Sensor type: Platinum resistance thermometer (Pt100 or JPt100)		CP1W-TS101
	4CH	--	Sensor type: Platinum resistance thermometer (Pt100 or JPt100)		CP1W-TS102
	4CH	--	Sensor type: Thermocouple (J or K) 2 channels can be used as analog input. Input range: 1 to 5 V, 0 to 10 V, 4-20 mA		Resolution: 1/12000 CP1W-TS003
	12CH	--	Sensor type: Thermocouple (J or K)		CP1W-TS004
<b>CompoBus/S I/O Link Unit</b> 	8	8	CompoBus/S slave		CP1W-SRT21

## ■ I/O Connecting Cable

Name	Specifications	Model
I/O Connecting Cable	80 cm (for CP1W Expansion Units)	CP1W-CN811

Note: An I/O Connecting Cable (approx. 6 cm) for horizontal connection is provided with CP1W Expansion Units.

## ■ Optional Products, Maintenance Products and DIN Track Accessories

Name	Specifications	Model
<b>Battery Set</b>	For CP1H CPU Units (Use batteries within two years of manufacture.)	CJ1W-BAT01
<b>DIN Track</b>	Length: 0.5 m; Height: 7.3 mm	PPF-50N
	Length: 1 m; Height: 7.3 mm	PPF-100N
	Length: 1 m; Height: 16 mm	PPF-100N2
<b>End Plate</b>	There are 2 stoppers provided with a CJ Unit Adapter as standard accessories to secure the Units on the DIN Track.	PPF-M

## ■ CJ-series Special I/O Units and CPU Bus Units

Category	Name	Specifications	Model
CP1H CPU Unit options	CJ Unit Adapter	Adapter for connecting CJ-series Special I/O Units and CPU Bus Units (includes CJ-series End Cover and 2 End Plates)	CP1W-EXT01
	Analog Input Units	4 inputs (1 to 5 V (1/10,000), 0 to 10 V (1/20,000), -5 to 5 V (1/20,000), -10 to 10 V (1/40,000), and 4 to 20 mA (1/10,000)) Conversion Period: 20 μs/1 point, 25 μs/2 points, 30 μs/3 points, 35 μs/4 points	CJ1W-AD042
Analog Input Units		8 inputs (1 to 5 V, 0 to 5 V, 0 to 10 V, -10 to 10 V, 4 to 20 mA) Resolution: 1/8,000, Conversion speed: 250 μs/input max. (Can be set to 1/4,000 resolution and 1 ms/input.)	CJ1W-AD081-V1
	Analog Input Units	4 inputs (1 to 5 V, 0 to 5 V, 0 to 10 V, -10 to 10 V, 4 to 20 mA) Resolution: 1/8,000, Conversion speed: 250 μs/input max. (Can be set to 1/4,000 resolution and 1 ms/input.)	CJ1W-AD041-V1
Analog Output Units		4 outputs (1 to 5 V (1/10,000), 0 to 10 V (1/20,000), and -10 to 10 V (1/40,000)) Conversion Period: 20 μs/1 point, 25 μs/2 points, 30 μs/3 points, 35 μs/4 points	CJ1W-DA042V
	8 outputs (1 to 5 V, 0 to 5 V, 0 to 10 V, -10 to 10 V) Resolution: 1/4,000; Conversion speed: 1 ms/output max. (Can be set to 1/8000, 250 μs/output.)	CJ1W-DA08V	
	8 outputs (4 to 20 mA) Resolution: 1/4,000; Conversion speed: 1 ms/output max. (Can be set to 1/8,000, 250 μs/output.)	CJ1W-DA08C	
	4 outputs (1 to 5 V, 0 to 5 V, 0 to 10 V, -10 to 10 V, 4 to 20 mA) Resolution: 1/4,000, Conversion speed: 1ms/point max.	CJ1W-DA041	
	2 outputs (1 to 5 V, 0 to 5 V, 0 to 10 V, -10 to 10 V, 4 to 20 mA) Resolution: 1/4,000, Conversion speed: 1ms/point max.	CJ1W-DA021	
Analog I/O Unit	4 inputs, 2 outputs (1 to 5 V, 0 to 5 V, 0 to 10 V, -10 to 10 V, 4 to 20 mA) Resolution: 1/4000; Conversion speed: 1 ms/point max. (Can be set to 1/8,000, 500 μs/point.)	CJ1W-MAD42	
CJ1 Special I/O Units	Process Input Units	4 fully universal inputs: Pt100 (3-wire), JPt100 (3-wire), Pt1000 (3-wire), Pt100 (4 wire), K, J, T, E, L, U, N, R, S, B, WRe5-26, PLII, 4 to 20 mA, 0 to 20 mA, 1 to 5 V, 0 to 1.25 V, 0 to 5 V, 0 to 10 V, ±100-mV selectable range, -1.25 to 1.25 V, -5 to 5 V, -10 to 10 V, ±10-V selectable range Potentiometer resolution/conversion speed: 1/256,000 (conversion cycle: 60 ms/4 points), 1/64,000 (conversion cycle: 10 ms/4 points), 1/16,000 (conversion cycle: 5 ms/4 points)	CJ1W-PH41U *
		4 fully universal inputs: Pt100, JPt100, Pt1000, K, J, T, L, R, S, B, 4 to 20 mA, 0 to 20 mA, 1 to 5 V, 0 to 5 V, 0 to 10 V Conversion speed: 250 ms/4 points	CJ1W-AD04U
	4 inputs, B, J, K, L, R, S, T; Conversion speed: 250 ms/4 inputs	CJ1W-PTS51	
	4 inputs, Pt100 Ω (JIS, IEC), JPt100 Ω, Conversion speed: 250 ms/4 inputs	CJ1W-PTS52	
	2 inputs, B, E, J, K, L, N, R, S, T, U, W, Re5-26, PL ±100 mV, Resolution: 1/64,000; Conversion speed: 10 ms/2 inputs	CJ1W-PTS15	
	2 inputs, 0 to 1.25 V, -1.25 to 1.25 V, 0 to 5 V, 1 to 5 V, -5 to 5 V, 0 to 10 V, -10 to 10 V, ±10-V selectable range, 0 to 20 mA, 4 to 20 mA	CJ1W-PDC15	
	Temperature Control Units	4 loops, thermocouple input, NPN output	CJ1W-TC001
4 loops, thermocouple input, PNP output		CJ1W-TC002	
2 loops, thermocouple input, NPN output, heater burnout detection function		CJ1W-TC003	
2 loops, thermocouple input, PNP output, heater burnout detection function		CJ1W-TC004	
4 loops, platinum resistance thermometer input, NPN output		CJ1W-TC101	
4 loops, platinum resistance thermometer input, PNP output		CJ1W-TC102	
2 loops, platinum resistance thermometer input, NPN output, heater burnout detection function		CJ1W-TC103	
2 loops, platinum resistance thermometer input, PNP output, heater burnout detection function		CJ1W-TC104	
High-speed Counter Unit	2 inputs, max. input frequency: 500 kpps	CJ1W-CT021	
Position Control Units	Pulse train, open collector output, 1 axis	CJ1W-NC113	
	Pulse train, open collector output, 2 axes	CJ1W-NC213	
	Pulse train, open collector output, 4 axes	CJ1W-NC413	
	Pulse train, line driver output, 1 axis	CJ1W-NC133	
	Pulse train, line driver output, 2 axes	CJ1W-NC233	
	Pulse train, line driver output, 4 axes	CJ1W-NC433	
Space Unit	---	CJ1W-SP001	
ID Sensor Units	For V680 Series, 1 R/W Head	CJ1W-V680C11	
	For V680 Series, 2 R/W Heads	CJ1W-V680C12	
	For V600 Series, 1 R/W Head	CJ1W-V600C11	
	For V600 Series, 2 R/W Heads	CJ1W-V600C12	
CompoNet Master Unit	Word slaves: 2,048 points, Bit slaves: 512 points	CJ1W-CRM21	
CompoBus/S Master Unit	CompoBus/S remote I/O, 256 points max.	CJ1W-SRM21	



\* If a CJ1W-PH41U is used, do not use a CP1H CPU Unit with relay contact outputs or Expansion Units with relay contact outputs.

**Note:** Refer to the *CJ1 catalog* (Cat. No. P052) for information on the CJ1 Special I/O Units.

Category	Name	Specifications	Model	
CJ1 CPU Bus Units	Controller Link Units	Wired (shielded twisted-pair cable)	CJ1W-CLK23	
	Serial Communications Units	1 RS-232C port and 1 RS-422A/485 port	CJ1W-SCU42	
		2 RS-232C ports	CJ1W-SCU22	
		2 RS-422A/485 ports	CJ1W-SCU32	
		1 RS-232C port and 1 RS-422A/485 port	CJ1W-SCU41-V1	
		2 RS-232C ports	CJ1W-SCU21-V1	
		2 RS-422A/485 ports	CJ1W-SCU31-V1	
	EtherNet/IP Unit	Shielded twisted-pair cable (STP), category 5 or 5e or higher Tag data links and message communications supported	CJ1W-EIP21	
	Ethernet Unit	100Base-TX	CJ1W-ETN21	
	DeviceNet™ Unit	Functions as master and/or slave; allows control of 32,000 points max. per master	CJ1W-DRM21	
	MECHATROLINK-II Position Control Unit	Control commands sent using MECHATROLINK-II synchronized communications 16 axes max., direct operation from ladder diagram, control modes: position/ speed/torque	2 axes	CJ1W-NC271
			4 axes	CJ1W-NC471
			16 axes	CJ1W-NCF71
16 axes			CJ1W-NCF71-MA	
FI-net Unit	100Base-TX	CJ1W-FLN22		
SPU	High-speed Data Storage Unit	CJ1W-SPU01-V2		

Note: Refer to the *CJ1 catalog* (Cat. No. P052) for information on the CJ1 CPU Bus Units.

## Industrial Switching Hubs

Product name	Appearance	Specifications			Accessories	Current consumption (A)	Model
		Functions	No. of ports	Failure detection			
Industrial Switching Hubs		Quality of Service (QoS): EtherNet/IP™ control data priority Failure detection: Broadcast storm and LSI error detection 10/100BASE-TX, Auto-Negotiation	3	No	• Power supply connector	0.22	W4S1-03B
	5		No	0.22		W4S1-05B	
			5	Yes	• Power supply connector • Connector for informing error	0.22	W4S1-05C

## General Specifications

Item	Type Model	AC power supply models	DC power supply models
		CP1H-□□□-A	CP1H-□□□-D
Power supply		100 to 240 VAC 50/60 Hz	24 VDC
Operating voltage range		85 264 VAC	20.4 to 26.4 VDC (with 4 or more Expansion Units and Expansion I/O Units: 21.6 to 26.4 VDC)
Power consumption		100 VA max. (CP1H-□□□-A)(page 28)	50 W max. (CP1H-□□□-D)(page 28)
Inrush current (See note.)		100 to 120 VAC inputs: 20 A max. (for cold start at room temperature) 8 ms max. 200 to 240 VAC inputs: 40 A max. (for cold start at room temperature), 8 ms max.	30 A max. (for cold start at room temperature) 20 ms max.
External power supply		300 mA at 24 VDC	None
Insulation resistance		20 MΩ min. (at 500 VDC) between the external AC terminals and GR terminals	No insulation between primary and secondary for DC power supply
Dielectric strength		2,300 VAC at 50/60 Hz for 1 min between the external AC and GR terminals, leakage current: 5 mA max.	No insulation between primary and secondary for DC power supply
Noise immunity		Conforms to IEC 61000-4-4. 2 kV (power supply line)	
Vibration resistance		Conforms to JIS C60068-2-6. 10 to 57 Hz, 0.075-mm amplitude, 57 to 150 Hz, acceleration: 9.8 m/s <sup>2</sup> in X, Y, and Z directions for 80 minutes each. Sweep time: 8 minutes × 10 sweeps = total time of 80 minutes)	
Shock resistance		Conforms to JIS C60068-2-27. 147 m/s <sup>2</sup> three times each in X, Y, and Z directions	
Ambient operating temperature		0 to 55°C	
Ambient humidity		10% to 90% (with no condensation)	
Ambient operating environment		No corrosive gas	
Ambient storage temperature		-20 to 75°C (Excluding battery.)	
Power holding time		10 ms min.	2 ms min.

**Note:** The above values are for a cold start at room temperature for an AC power supply, and for a cold start for a DC power supply.

- A thermistor (with low-temperature current suppression characteristics) is used in the inrush current control circuitry for the AC power supply. The thermistor will not be sufficiently cooled if the ambient temperature is high or if a hot start is performed when the power supply has been OFF for only a short time. In those cases the inrush current values may be higher (as much as two times higher) than those shown above. Always allow for this when selecting fuses and breakers for external circuits.
- A capacitor charge-type delay circuit is used in the inrush current control circuitry for the DC power supply. The capacitor will not be charged if a hot start is performed when the power supply has been OFF for only a short time, so in those cases the inrush current values may be higher (as much as two times higher) than those shown above.

# CP1H

## Performance Specifications

Item	Type Models	CP1H-XA CPU Units	CP1H-X CPU Units	CP1H-Y CPU Units
		CP1H-XA□□□-□	CP1H-X□□□□-□	CP1H-Y□□□□-□
Control method		Stored program method		
I/O control method		Cyclic scan with immediate refreshing		
Program language		Ladder diagram		
Function blocks		Maximum number of function block definitions: 128 Maximum number of instances: 256 Languages usable in function block definitions: Ladder diagrams, structured text (ST)		
Instruction length		1 to 7 steps per instruction		
Instructions		Approx. 500 (function codes: 3 digits)		
Instruction execution time		Basic instructions: 0.10 μs min. Special instructions: 0.15 μs min.		
Common processing time		0.7 ms		
Program capacity		20K steps		
Number of tasks		288 (32 cyclic tasks and 256 interrupt tasks)		
	Scheduled interrupt tasks	1 (interrupt task No. 2, fixed)		
	Input interrupt tasks	8 (interrupt task No. 140 to 147, fixed)	6 (interrupt task No. 140 to 145, fixed)	
		(Interrupt tasks can also be specified and executed for high-speed counter interrupts.)		
Maximum subroutine number		256		
Maximum jump number		256		
I/O areas (See note.)	Input bits	272bits (17 words) : CIO 0.00 to 16.15		
	Output bits	272bits (17 words) : CIO 100.00 to 116.16		
	Built-in Analog Inputs	CIO 200 to CIO 203	---	
	Built-in Analog Outputs	CIO 210 to CIO 211	---	
	Serial PLC Link Area	1,440 bits (90 words): CIO 3100.00 to CIO 3189.15 (CIO 3100 to CIO 3189)		
Work bits	8,192 bits (512 words): W0.00 to W511.15 (W0 to W511) CIO Area: 37,504 bits (2,344 words): CIO 3800.00 to CIO 6143.15 (CIO 3800 to CIO 6143)			
TR Area	16 bits: TR0 to TR15			
Holding Area	8,192 bits (512 words): H0.00 to H511.15 (H0 to H511)			
AR Area	Read-only (Write-prohibited): 7168 bits (448 words): A0.00 to A447.15 (A0 to A447) Read/Write: 8192 bits (512 words): A448.00 to A959.15 (A448 to A959)			
Timers	4,096 bits: T0 to T4095			
Counters	4,096 bits: C0 to C4095			
DM Area	32 Kwords: D0 to D32767			
Data Register Area	16 registers (16 bits): DR0 to DR15			
Index Register Area	16 registers (32 bits): IR0 to IR15			
Task Flag Area	32 flags (32 bits): TK0000 to TK0031			
Trace Memory	4,000 words (500 samples for the trace data maximum of 31 bits and 6 words.)			
Memory Cassette	A special Memory Cassette (CP1W-ME05M) can be mounted. Note: Can be used for program backups and auto-booting.			
Clock function	Supported. Accuracy (monthly deviation): -4.5 min to -0.5 min (ambient temperature: 55°C), -2.0 min to +2.0 min (ambient temperature: 25°C), -2.5 min to +1.5 min (ambient temperature: 0°C)			
Communications functions	One built-in peripheral port (USB 1.1): For connecting Support Software only.			
	A maximum of two Serial Communications Option Boards can be mounted.			
	A maximum of two Ethernet Option Boards can be mounted. When using CP1W-CIF41 Ver.1.0, one Ethernet Option Board can be mounted.			
Memory backup	Flash memory: User programs, parameters (such as the PLC Setup), comment data, and the entire DM Area can be saved to flash memory as initial values. Battery backup: The Holding Area, DM Area, and counter values (flags, PV) are backed up by a battery.			
Battery service life	5 years at 25°C. (Use the replacement battery within two years of manufacture.)			
Built-in input terminals	40 (24 inputs, 16 outputs)	20 (12 inputs, 8 outputs) Line-driver inputs: Two axes for phases A, B, and Z Line-driver outputs: Two axes for CW and CCW		
Number of connectable Expansion (I/O) Units	CP Expansion I/O Units: 7 max.; CJ-series Special I/O Units or CPU Bus Units: 2 max.			
Max. number of I/O points	320 (40 built in + 40 per Expansion (I/O) Unit × 7 Units)	300 (20 built in + 40 per Expansion (I/O) Unit × 7 Units)		
Interrupt inputs	8 inputs (Shared by the external interrupt inputs (counter mode) and the quick-response inputs.)	6 inputs (Shared by the external interrupt inputs (counter mode) and the quick-response inputs.)		
Interrupt input counter mode	8 inputs (Response frequency: 5 kHz max. for all interrupt inputs), 16 bits Up or down counters	6 inputs (Response frequency: 5 kHz max. for all interrupt inputs), 16 bits Up or down counters		
Quick-response inputs	8 points (Min. input pulse width: 50 μs max.)	6 points (Min. input pulse width: 50 μs max.)		
Scheduled interrupts	1			



Type		CP1H-XA CPU Units	CP1H-X CPU Units	CP1H-Y CPU Units
Item	Models	CP1H-XA□□□-□	CP1H-X□□□-□	CP1H-Y□□□-□
<b>High-speed counters</b>		4 inputs: Differential phases (4x), 50 kHz or Single-phase (pulse plus direction, up/down, increment), 100 kHz Value range: 32 bits, Linear mode or ring mode Interrupts: Target value comparison or range comparison		2 inputs: Differential phases (4x), 500 kHz or Single-phase, 1 MHz and 2 inputs: Differential phases (4x), 50 kHz or Single-phase (pulse plus direction, up/down, increment), 100 kHz Value range: 32 bits, Linear mode or ring mode Interrupts: Target value comparison or range comparison
<b>Pulse outputs (models with transistor outputs only)</b>	<b>Pulse outputs</b>	Trapezoidal or S-curve acceleration and deceleration (Duty ratio: 50% fixed) 4 outputs, 1 Hz to 100 kHz (CCW/CW or pulse plus direction)		Trapezoidal or S-curve acceleration and deceleration (Duty ratio: 50% fixed) 2 outputs, 1 Hz to 1 MHz (CCW/CW or pulse plus direction) 2 outputs, 1 Hz to 100 kHz (CCW/CW or pulse plus direction)
	<b>PWM outputs</b>	Duty ratio: 0.0% to 100.0% (Unit: 0.1%) 2 outputs, 0.1 to 6553.5 Hz (Accuracy: ±5% at 1 kHz)		
<b>Built-in analog I/O terminals</b>		4 analog inputs and 2 analog outputs	None	
<b>Analog control</b>		1 (Setting range: 0 to 255)		
<b>External analog input</b>		1 input (Resolution: 1/256, Input range: 0 to 10 V), not isolated		

**Note:** The memory areas for CJ-series Special I/O Units and CPU Bus Units are allocated at the same as for the CJ-series. For details, refer to the CJ Series catalog (Cat. No. P052).

# CP1H

## Built-in Inputs / Built-in Outputs

### Terminal Block Arrangement

#### ● CP1H-XA and X CPU Units with AC Power Supply



#### ● CP1H-XA and X CPU Units with DC Power supply

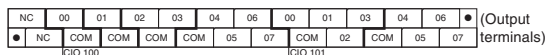
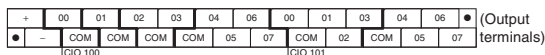

### Built-in Input Area

#### ● CP1H-XA and X CPU Units

PLC Setup	Input operation			High-speed counter operation	Pulse output origin search function set to be used.	
	Normal inputs	Interrupt inputs	Quick-response inputs	High-speed counters	Origin search	
CIO 0	00	Normal input 0	Interrupt input 0	Quick-response input 0	Pulse 0: Origin input signal	
	01	Normal input 1	Interrupt input 1	Quick-response input 1	High-speed counter 2 (phase-Z/reset)	Pulse 0: Origin proximity input signal
	02	Normal input 2	Interrupt input 2	Quick-response input 2	High-speed counter 1 (phase-Z/reset)	Pulse output 1: Origin input signal
	03	Normal input 3	Interrupt input 3	Quick-response input 3	High-speed counter 0 (phase-Z/reset)	Pulse output 1: Origin proximity input signal
	04	Normal input 4			High-speed counter 2 (phase-A, increment, or count input)	
	05	Normal input 5			High-speed counter 2 (phase-B, decrement, or direction input)	
	06	Normal input 6			High-speed counter 1 (phase-A, increment, or count input)	
	07	Normal input 7			High-speed counter 1 (phase-B, decrement, or direction input)	
	08	Normal input 8			High-speed counter 0 (phase-A, increment, or count input)	
	09	Normal input 9			High-speed counter 0 (phase-B, decrement, or direction input)	
	10	Normal input 10			High-speed counter 3 (phase-A, increment, or count input)	
CIO 1	00	Normal input 12	Interrupt input 4	Quick-response input 4	High-speed counter 3 (phase-Z/reset)	Pulse output 2: Origin input signal
	01	Normal input 13	Interrupt input 5	Quick-response input 5		Pulse output 2: Origin proximity input signal
	02	Normal input 14	Interrupt input 6	Quick-response input 6		Pulse output 3: Origin input signal
	03	Normal input 15	Interrupt input 7	Quick-response input 7		Pulse output 3: Origin proximity input signal
	04	Normal input 16				
	05	Normal input 17				
	06	Normal input 18				
	07	Normal input 19				
	08	Normal input 20				
	09	Normal input 21				
	10	Normal input 22				
11	Normal input 23					

### Built-in Output Area

#### ● CP1H-XA and CP1H-X CPU Units

Instructions	When the instructions to the right are not executed	When a pulse output instruction (SPED, ACC, PLS2, or ORG) is executed	When the origin search function is set to be used in the PLC Setup, and an origin search is executed by the ORG instruction		When the PWM instruction is executed
			When the origin search function is used		
PLC Setup	Normal outputs	Fixed duty ratio pulse outputs			Variable duty ratio pulse output
		CW/CCW	Pulse plus direction		
CIO 100	00	Normal output 0	Pulse output 0 (CW)	Pulse output 0 (pulse)	
	01	Normal output 1	Pulse output 0 (CCW)	Pulse output 1 (pulse)	
	02	Normal output 2	Pulse output 1 (CW)	Pulse output 0 (direction)	
	03	Normal output 3	Pulse output 1 (CCW)	Pulse output 1 (direction)	
	04	Normal output 4	Pulse output 2 (CW)	Pulse output 2 (pulse)	
	05	Normal output 5	Pulse output 2 (CCW)	Pulse output 2 (direction)	
	06	Normal output 6	Pulse output 3 (CW)	Pulse output 3 (pulse)	
CIO 101	00	Normal output 8			PWM output 0
	01	Normal output 9			PWM output 1
	02	Normal output 10			Origin search 0 (Error counter reset output)
	03	Normal output 11			Origin search 1 (Error counter reset output)
	04	Normal output 12			Origin search 2 (Error counter reset output)
CIO 101	06	Normal output 14			
	07	Normal output 15			

■ Terminal Block Arrangement

● CP1H-Y CPU Units

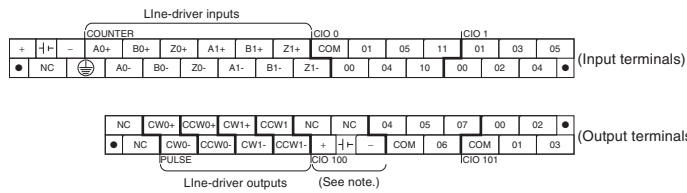

Note: Supply 24 VDC to the bottom 24 VDC input terminals when using bits 04 to 07 of output word CIO 100.

■ Built-in Input Area

● CP1H-Y CPU Units

PLC Setup	Input operation setting				High-speed counter operation setting	Pulse output origin search function set to be used.
	Normal inputs	Interrupt inputs	Quick-response inputs	High-speed counters		Origin search
A0				High-speed counter 0 (phase-A, increment, or count input) fixed		
B0				High-speed counter 0 (phase-B, decrement, or direction input) fixed		
Z0				High-speed counter 0 (phase-Z/reset) fixed		Pulse 0: Origin input signal (line driver)
A1				High-speed counter 1 (phase-A, increment, or count input) fixed		
B1				High-speed counter 1 (phase-B, decrement, or direction input) fixed		
Z1				High-speed counter 1 (phase-Z/reset) fixed		Pulse 1: Origin input signal (line driver)
CIO 0	Bit 00	Normal input 0	Interrupt 0	Quick-response input 0		Pulse 2: Origin proximity input signal
	Bit 01	Normal input 1	Interrupt 1	Quick-response input 1	High-speed counter 2 (phase-Z/reset)	
	Bit 04	Normal input 2			High-speed counter 2 (phase-A, increment, or count input)	
	Bit 05	Normal input 3			High-speed counter 2 (phase-B, decrement, or direction input)	
	Bit 10	Normal input 4			High-speed counter 3 (phase-A, increment, or count input)	
	Bit 11	Normal input 5			High-speed counter 2 (phase-B, decrement, or direction input)	Pulse 3: Origin proximity input signal
CIO 1	Bit 00	Normal input 6	Interrupt 2	Quick-response input 2	High-speed counter 2 (phase-Z/reset)	Pulse 3: Origin input signal
	Bit 01	Normal input 7	Interrupt 3	Quick-response input 3		Pulse 2: Origin input signal
	Bit 02	Normal input 8	Interrupt 4	Quick-response input 4		Pulse 1: Origin input signal (open collector)
	Bit 03	Normal input 9	Interrupt 5	Quick-response input 5		Pulse 0: Origin input signal (open collector)
	Bit 04	Normal input 10				Pulse 1: Origin proximity input signal
	Bit 05	Normal input 11				Pulse 0: Origin proximity input signal

These areas are for line-driver inputs, so they can be used only for high-speed counters (1 MHz) and not for other purposes, such as normal inputs.

■ Built-in Output Area

● CP1H-Y CPU Units

Instructions	When the instructions to the right are not executed	When a pulse output instruction (SPED, ACC, PLS2, or ORG) is executed		When the origin search function is set to be used in the PLC Setup, and an origin search is executed by the ORG instruction	When the PWM instruction is executed
		CW/CCW	Pulse plus direction	When the origin search function is used	PWM output
CW0	Not supported.	Pulse output 0 (CW) fixed	Pulse output 0 (pulse) fixed		
CCW0	Not supported.	Pulse output 0 (CCW) fixed	Pulse output 1 (pulse) fixed		
CW1	Not supported.	Pulse output 1 (CW) fixed	Pulse output 0 (direction) fixed		
CCW1	Not supported.	Pulse output 1 (CCW) fixed	Pulse output 1 (direction) fixed		
CIO 100	Bit 04	100.04	Pulse output 2 (CW)	Pulse output 2 (pulse)	
	Bit 05	100.05	Pulse output 2 (CCW)	Pulse output 2 (direction)	
	Bit 06	100.06	Pulse output 3 (CW)	Pulse output 3 (pulse)	
	Bit 07	100.07	Pulse output 3 (CCW)	Pulse output 3 (direction)	
CIO 101	Bit 00	101.00		Origin search 2 (Error counter reset output)	PWM output 0
	Bit 01	101.01		Origin search 3 (Error counter reset output)	PWM output 1
	Bit 02	101.02		Origin search 0 (Error counter reset output)	
	Bit 03	101.03		Origin search 1 (Error counter reset output)	

These areas are for line-driver inputs, so they can be used only for high-speed counters (1 MHz) and not for other purposes, such as normal inputs.

# CP1H

## I/O Specifications for CPU Units

### Input Specifications

ITEM	Specifications		
	High-speed counter inputs (phases A and B)	Interrupt inputs and quick-response inputs	Normal inputs
CP1H-XA/X CPU Units	CIO 0.04 to CIO 0.11	CIO 0.00 to CIO 0.03 and CIO 1.00 to CIO 1.03	CIO 1.04 to CIO 1.11
CP1H-Y CPU Units	CIO 0.04, CIO 0.05, CIO 0.10, CIO 0.11	CIO 0.00, CIO 0.01 and CIO 1.00 to CIO 1.03	CIO 1.04, CIO 1.05
Input voltage	24 VDC +10%/−15%		
Applicable sensors	2-wire sensors or 3-wire sensors		
Input impedance	3.0 kΩ		4.7 kΩ
Input current	7.5 mA typical		5 mA typical
ON voltage	17.0 VDC min.		14.4 VDC min.
OFF voltage/current	1 mA max. at 5.0 VDC		
ON delay	2.5 μs max.	50 μs max.	1 ms max.
OFF delay	2.5 μs max.	50 μs max.	1 ms max.
Circuit configuration			

### High-speed Counter Function Input Specifications

CP1H-XA/X CPU Units (Input bits: CIO 0.04 to CIO 0.11)

CP1H-Y CPU Units (Input bits: CIO 0.04, CIO 0.05, CIO 0.10, CIO 0.11)

Item	Specifications
ON/OFF delay	<ul style="list-style-type: none"> <li>Pulse plus direction input mode</li> <li>Increment mode</li> <li>Up/down input mode</li> </ul> <ul style="list-style-type: none"> <li>Differential phase input mode</li> </ul>

### Interrupt Input Counter Mode

CP1H-XA/X CPU Units (Input bits: CIO 0.00 to CIO 0.03, CIO 1.00 to CIO 1.03)

CP1H-Y CPU Units (Input bits: CIO 0.00, CIO 0.11, CIO 1.00 to CIO 1.03)

Item	Specifications
ON/OFF delay	

### High-speed Counter Inputs (Line-driver Inputs)

CP1H-Y CPU Units

Item	Specifications
High-speed counter inputs	Phases A and B <span style="float: right;">Phase Z</span>
Input voltage	RS-422A line-driver, AM26LS31 or equivalent Note: The power supply voltage on the line-driver must be 5 V±5% max.
Input type	Line-driver input
Input current	10 mA typical <span style="float: right;">13 mA typical</span>
Circuit configuration	
ON/OFF delay	<ul style="list-style-type: none"> <li>Pulse plus direction input mode</li> <li>Increment mode</li> <li>Up/down input mode</li> </ul> <ul style="list-style-type: none"> <li>Differential phase input mode</li> </ul>

■ Output Specifications

● CPU Units with Relay Outputs

Item		Specifications	
Max. switching capacity		2 A, 250 VAC (cosφ = 1), 2 A, 24 VDC 4 A/common	
Min. switching capacity		5 VDC, 10 mA	
Service life of relay	Electrical	Resistive load	100,000 operations (24 VDC)
		Inductive load	48,000 operations (250 VAC, cosφ = 0.4)
	Mechanical		20,000,000 operations
ON delay		15 ms max.	
OFF delay		15 ms max.	
Circuit configuration			

**Note:** Under the worst conditions, the service life of output contacts is as shown on the left.  
The service life of relays is as shown in the following diagram as a guideline.

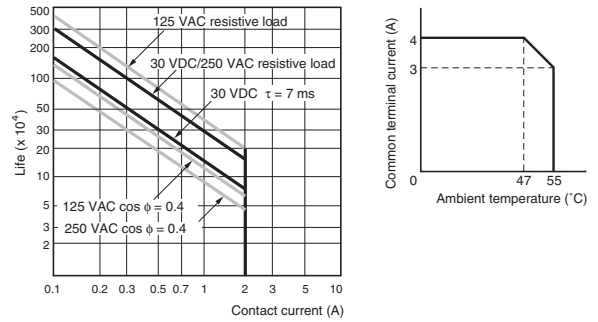

● CPU Units with Transistor Outputs (Sinking/Sourcing)

Item	Specifications			
	CP1H-XA/X CPU Units	CIO 100.00 to CIO 100.07	CIO 101.00, CIO 101.01	CIO 101.02 to CIO 101.07
CP1H-Y CPU Units	CIO 100.04 to CIO 100.07	CIO 101.00, CIO 101.01	CIO 101.02, CIO 101.03	
Max. switching capacity	4.5 to 30 VDC: 300 mA/point, 0.9 A/common, 3.6 A/Unit *1*2			
Min. switching capacity	4.5 to 30 VDC, 1 mA			
Leakage current	0.1 mA max.			
Residual voltage	0.6 V max.		1.5 V max.	
ON delay	0.1 ms max.			
OFF delay	0.1 ms max.		1 ms max.	
Fuse	1/common *3			
Circuit configuration	<p>Sinking Outputs</p> <p>Sourcing Outputs</p>		<p>Sinking Outputs</p> <p>Sourcing Outputs</p>	

**Note: 1.** Do not apply a voltage or connect a load to an output terminal exceeding the maximum switching capacity.

- \*1 Also do not exceed 0.9 A for the total for CIO 100.00 to CIO 100.03. (CIO 100.00 to CIO 100.03 is different common.)
- \*2 A maximum of 0.9 A per common can be switched at an ambient temperature of 50 °C.
- \*3 Fuses cannot be replaced by the user.

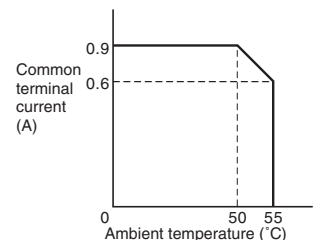

# CP1H

## ● Pulse outputs

CP1H-XA/X CPU Units: Output bits CIO 100.00 to CIO 100.07  
 CP1H-Y CPU Units: Output bits CIO100.04 to CIO 100.07

Item	Specifications
Max. switching capacity	30 mA at 4.75 to 26.4 VDC
Min. switching capacity	7 mA at 4.75 to 26.4 VDC
Max. output frequency	100 kHz
Output waveform	

- Note:** 1. The above values assume a resistive load and do not consider the impedance of the cable connecting the load.  
 2. The pulse widths during actual use may be smaller than the ones shown above due to pulse distortion caused by connecting cable impedance.  
 3. The OFF and ON refer to the output transistor. The output transistor is ON at level "L".

## ● Pulse Outputs (Line-driver Outputs)

CP1H-Y CPU Units

Item	Specifications
Pulse outputs	Line-driver outputs, Am26LS31 or equivalent
Max. output current	20 mA
Max. output frequency	1 MHz
Circuit configuration	

**Note:** Connect a load of 20 mA or less to the output. The Unit may be damaged if a current of more than 20 mA is output.

## ■ Analog I/O Specifications (CP1H-XA CPU Units Only)

Item		Voltage I/O	Current I/O
Analog Input Section	Number of analog inputs	4	
	Input signal range	0 to 5 V, 1 to 5 V, 0 to 10 V, or -10 to 10 V	0 to 20 mA or 4 to 20 mA
	Max. rated input	±15 V	±30 mA
	External input impedance	1 MΩ min.	Approx. 250 Ω
	Resolution	1/6,000 or 1/12,000 (full scale)	
	Overall accuracy	25°C: ±0.3% full scale/0 to 55°C: ±0.6% full scale	25°C: ±0.4% full scale/0 to 55°C: ±0.8% full scale
	A/D conversion data	Full scale for -10 to 10 V: F448 (E890) to 0BB8 (1770) hex Full scale for other ranges: 0000 to 1770 (2EE0) hex	
	Averaging	Supported (Set for individual inputs in the PLC Setup.)	
	Open-circuit detection	Supported (Value when disconnected: 8000 Hex)	
Analog Output Section	Number of outputs	2	
	Output signal range	0 to 5 V, 1 to 5 V, 0 to 10 V, -10 to 10 V	0 to 20 mA or 4 to 20 mA
	Allowable external output load resistance	1 kΩ min.	600 Ω max.
	External output impedance	0.5 Ω max.	---
	Resolution	1/6000 or 1/12000 (full scale)	
	Overall accuracy	25°C±0.4% of full scale, 0 to 55°C±0.8% of full scale	
D/A conversion data	Full scale for -10 to 10 V: F448 (E890) to 0BB8 (1770) hex Full scale for other ranges: 0000 to 1770 (2EE0) hex		
Conversion time	1 ms/point		
Isolation method	Photocoupler isolation between analog I/O terminals and internal circuits. No isolation between analog I/O signals.		

### Built-in Analog Input Switch (Factory Settings)



## ● Pulse outputs

CP1H-XA/X/Y CPU Units: Output bits CIO101.00, CIO 101.01

Item	Specifications
Max. switching capacity	30 mA at 4.75 to 26.4 VDC
Max. output frequency	1 kHz
PWM output precision	ON duty +5%, -0% at output frequency of 1 kHz
Output waveform	

- Note:** 1. The above values assume a resistive load and do not consider the impedance of the cable connecting the load.  
 2. The pulse widths during actual use may be smaller than the ones shown above due to pulse distortion caused by connecting cable impedance.  
 3. The OFF and ON refer to the output transistor. The output transistor is ON at level "L".

### Built-in Analog I/O Terminal Block Arrangement

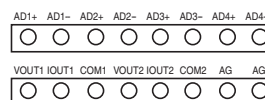

# External Interfaces

## ■ CPU Unit Nomenclature

### ●Front

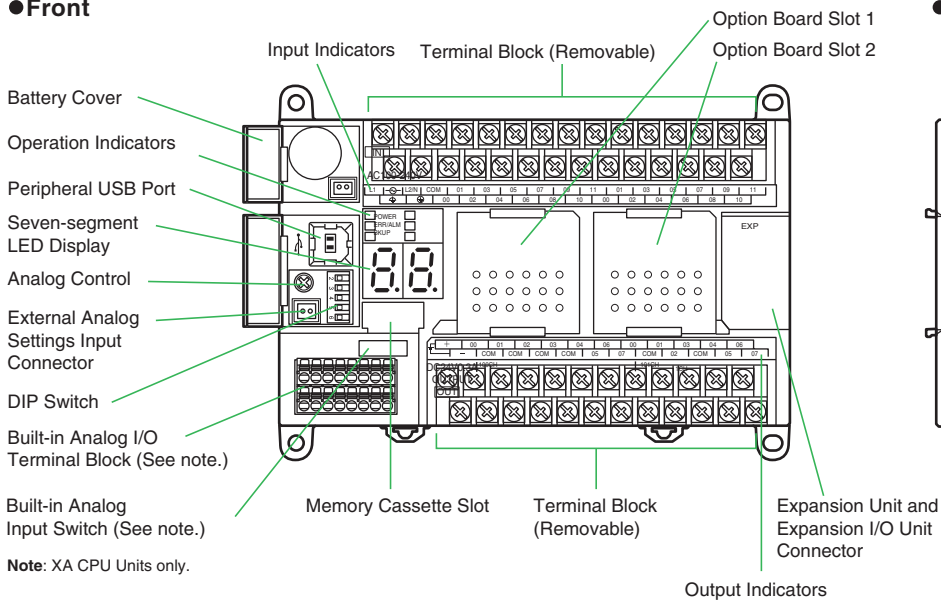

### ●Back

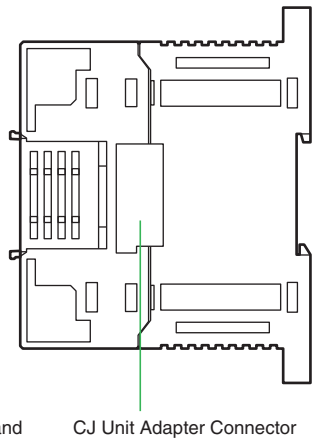

# CP1H

## Option Unit Specifications

### Serial Communications Specifications (CP1W-CIF01/-CIF11)

Item	Function	Interface
Peripheral USB port	For connecting Peripheral Device.	Conforms to USB 1.1, B-type connector
Serial port 1 (Option board slot 1)	Host Link, No-protocol, NT Link (1: N), Serial PLC Link (See note.), Serial Gateway (CompoWay/F master, Modbus-RTU master), Modbus-RTU easy master function, ToolBus	The following can be used for either port.  CP1W-CIF01 RS-232C Option Board
Serial port 2 (Option board slot 2)		CP1W-CIF11 RS-422A/485 Option Board (Maximum transmission distance 50m)  CP1W-CIF12-V1 RS-422A/485(Isolated-type) Option Board (Maximum transmission distance 500m)  Can be used with either port.

Note: Serial PLC Link can be used with either serial port 1 or serial port 2.

### Ethernet Communications Specifications (CP1W-CIF41)

Item	Specifications				
Applicable PLCs	CP1H CPU Units				
Number of Units that can be mounted	2 sets. (The CP1W-CIF41 Ver.1.0 and Ver.2.0 can be combined and used with one CPU Unit. When using CP1W-CIF41 Ver.1.0, only one unit can be mounted in an option board slot.)				
Transfer	Media access method	CSMA/CD			
	Modulation method	Baseband			
	Transmission paths	Star form			
	Baud rate	100 Mbit/s (100Base-TX), 10 Mbit/s (10Base-T)			
	Transmission media	<table border="1"> <tr> <td>100 Mbit/s</td> <td> <ul style="list-style-type: none"> <li>Unshielded twisted-pair (UDP) cable Categories: 5, 5e</li> <li>Shielded twisted-pair (STP) cable Categories: 100 Ω at 5, 5e</li> </ul> </td> </tr> <tr> <td>10 Mbit/s</td> <td> <ul style="list-style-type: none"> <li>Unshielded twisted-pair (UDP) cable Categories: 3, 4, 5, 5e</li> <li>Shielded twisted-pair (STP) cable Categories: 100 Ω at 3, 4, 5, 5e</li> </ul> </td> </tr> </table>	100 Mbit/s	<ul style="list-style-type: none"> <li>Unshielded twisted-pair (UDP) cable Categories: 5, 5e</li> <li>Shielded twisted-pair (STP) cable Categories: 100 Ω at 5, 5e</li> </ul>	10 Mbit/s
100 Mbit/s	<ul style="list-style-type: none"> <li>Unshielded twisted-pair (UDP) cable Categories: 5, 5e</li> <li>Shielded twisted-pair (STP) cable Categories: 100 Ω at 5, 5e</li> </ul>				
10 Mbit/s	<ul style="list-style-type: none"> <li>Unshielded twisted-pair (UDP) cable Categories: 3, 4, 5, 5e</li> <li>Shielded twisted-pair (STP) cable Categories: 100 Ω at 3, 4, 5, 5e</li> </ul>				
Transmission Distance	100 m (distance between hub and node)				

Item	FINS Communications Service Specifications	
Number of nodes	254	
Message length	1016 bytes max.	
Size of buffer	8k	
Communications Function	FINS Communications Service (UDP/IP, TCP/IP)	
FINS/UDP method	Protocol used	UDP/IP
	Server/Client	Only server (Cannot be used as a client)
	Port number	9600 (default) Can be changed.
	Protection	No
FINS/TCP method	Protocol used	TCP/IP
	Server/Client	Only server (Cannot be used as a client)
	Number of connections	Up to 2 simultaneous connections and only one connection can be set to client
	Port number	9600 (default) Can be changed.
Protection	Yes (Specification of client IP addresses when unit is used as a server)	

Note: 1. CX-Programmer version 8.1 or higher (CX-One version 3.1 or higher) is required.

2. Use CX-Integrator version 2.33 or higher (CX-One version 3.1 or higher) when the system needs to be set the routing tables. However, CX-Integrator does not support the other functions, using CP1W-CIF41, such as transferring the parameters and network structure.

3. To connect the CP1H CPUs with the NS-series Programmable Terminals via Ethernet using CP1W-CIF41, make sure that the system version of NS Series is 8.2 or higher.



■ LDC Option Board (CP1W-DAM01)

● Specifications

Item	Function
Mounting port	CP1H: Option board slot 1
Communications protocol	Peripheral bus (Turn ON DIP switch pin 4.)
Number of display characters	4 rows × 12 characters: 48 characters max.
Display characters	5 × 7 dots (alphanumeric and symbols).
Backlight	Electroluminescence (EL): Normal: Lit green; Error: Flashing red

● LCD Functions

Operation	Description
Changing operating modes	Change the PLC operating mode without using the CX-Programmer.
I/O memory	Read and change the present values in the memory areas and force-set or force-reset bits.
PLC Setup operations	Read and change the PLC Setup.
Analog I/O monitor	Monitor the analog adjustment and present value for the external analog setting input.
Error log display	Read the log of errors that have occurred.
Memory cassette operation	Transfer and verify user programs between the PLC and memory cassette.
User monitor settings	Read the status of up to 16 words and bits with comments. You can use this setting to read data on the startup display.
Message display function settings	Display a user-set message of up to 48 characters on the LCD Option Board when a specified bit turns ON. A maximum of 16 screens can be registered for display.
Timers	<p><b>Day timer</b></p> <p>Use this timer for ON/OFF switching at a specified times every day from the starting day of the week to the ending day of the week. Sixteen timers can be set from timer 01 to timer 16.</p> <p>Operation:</p>
	<p><b>Weekly timer</b></p> <p>Use this timer for ON/OFF operation in intervals of one week that starts one day and ends another day. Sixteen timers can be set from timer No. 01 to timer No. 16.</p> <p>Operation:</p>
	<p><b>Calendar timer</b></p> <p>Use the calendar timers for ON or OFF operation in intervals of one year from the starting day to the ending day. Sixteen timers can be set from timer 01 to timer 16.</p> <p>Operation:</p>
Saving setting	Save the various settings that you set with the LCD Option Board to the DM Area of the PLC. You can also write the settings saved in the PLC to the LCD Option Board.
Language	Changing the display language (Japanese/English)
Other functions	<ul style="list-style-type: none"> <li>• Setting the time of the PLC's built-in clock</li> <li>• Reading system data (e.g., unit version and lot number)</li> <li>• Setting the backlight lighting time</li> <li>• Adjusting LCD contrast</li> <li>• Reading cycle time (e.g., average, maximum, and minimum)</li> <li>• Clearing data for the LCD Option Board</li> </ul>

# CP1H

## Expansion I/O Unit Specifications

### ■ CP1W-40EDR/40EDT/40EDT1/32ER/32ET/32ET1/20EDR1/20EDT/20EDT1/16ER/16ET/16ET1/8ED/8ER/8ET/8ET1 Expansion I/O Units

Expansion I/O Units can be connected to the CPU Unit to configure the required number of I/O points.

#### ● DC Inputs (CP1W-40EDR/40EDT/40EDT1/20EDR1/20EDT/20EDT1/8ED)

Item	Specifications
Input voltage	24 VDC +10%/-15%
Input impedance	4.7 kΩ
Input current	5 mA typical
ON voltage	14.4 VDC min.
OFF voltage	5.0 VDC max.
ON delay	0 to 32 ms max. (Default: 8 ms) (See note 1.)
OFF delay	0 to 32 ms max. (Default: 8 ms) (See note 1.)
Circuit configuration	

**Note: 1.** Do not apply a voltage exceeding the rated voltage to an input terminal.  
**2.** Can be set in the PLC Setup to 0, 0.5, 1, 2, 4, 8, 16 or 32 ms. The CP1W-40EDR/EDT/EDT1 are fixed at 16 ms.

#### ● Relay Outputs (CP1W-40EDR/32ER/20EDR1/16ER/8ER)

Item	Specifications	
Max. switching capacity	2 A, 250 VAC (cosφ = 1), 24 VDC 4 A/common	
Min. switching capacity	5 VDC, 10 mA	
Service life of relay	Resistive load	150,000 operations (24 VDC)
	Inductive load	100,000 operations (24 VAC cos φ = 0.4)
	Mechanical	20,000,000 operations
ON delay	15 ms max.	
OFF delay	15 ms max.	
Circuit configuration	<p>Maximum 250 VAC; 2 A, 24 VDC; 2 A</p>	

**Note:** Under the worst conditions, the service life of output contacts is as shown on the left. The service life of relays is as shown in the following diagram as a guideline.

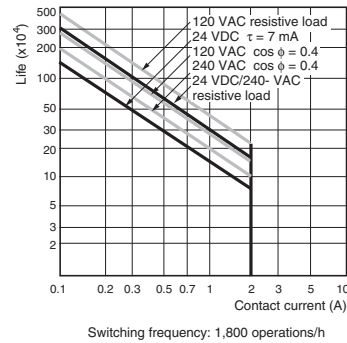

Relationship between Output Load Current and Ambient Temperature (CP1W-16ER/32ER)

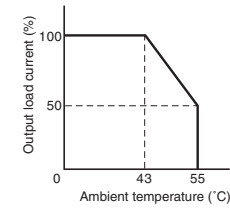

When using the CP1W-32ER, do not allow more than 24 outputs to be ON simultaneously regardless of the ambient temperature.

● Transistor Outputs (Sinking/Sourcing)  
 (CP1W-40EDT/-40EDT1/-32ET/-32ET1/-20EDT/-20EDT1/-16ET/-16ET1/-8ET/-8ET1)

Item	Specifications				
	CP1W-40EDT CP1W-40EDT1	CP1W-32E CP1W-32ET1	CP1W-20EDT CP1W-20EDT1	CP1W-16ET CP1W-16ET1	CP1W-8ET CP1W-8ET1
Max. switching capacity (See note 3.)	4.5 to 30 VDC: 0.3 A/point		24 VAC +10%/-5%: 0.3 A/point	4.5 to 30 VDC: 0.3 A/point	<ul style="list-style-type: none"> <li>OUT00/01 4.5 to 30 VDC, 0.2 A/output</li> <li>OUT02 to 07 4.5 to 30 VDC, 0.3A/output</li> </ul>
	0.9 A/common 3.6 A/common		0.9 A/common 1.8 A/common	0.9 A/common 3.6 A/common	0.9 A/common 1.8 A/common
Leakage current	0.1 mA max.				
Residual voltage	1.5 V max.				
ON delay	0.1ms max.				
OFF delay	1 ms max. at 24 VDC +10%/-5%, 5 to 300 mA				
Max number of Simultaneously ON Points of Output	16 pts (100%)	24 pts (75%)	8 pts (100%)	16 pts (100%)	8 pts (100%)
Fuse (See note 2.)	1/common				
Circuit configuration	Sinking Outputs		Sourcing Outputs		

- Note:**
1. Do not apply a voltage or connect a load to an output terminal exceeding the maximum switching capacity.
  2. The fuses cannot be replaced by the user.
  3. A maximum of 0.9 A per common can be switched at an ambient temperature of 50°C.

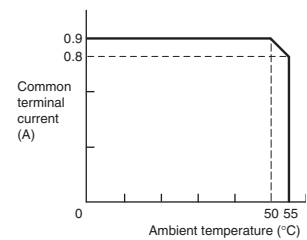

## ■ CP1W-AD041/AD042/DA021/DA041/DA042/MAD11/MAD42/MAD44 Analog Units

Analog values that are input are converted to binary data and stored in the input area, or binary data is output as analog values.

### ● Analog Input Units

Model		CP1W-AD041		CP1W-AD042	
Item		Voltage Input	Current Input	Voltage Input	Current Input
Number of inputs		4 inputs (4 words allocated)			
Input signal range		0 to 5 VDC, 1 to 5 VDC, 0 to 10 VDC, or -10 to 10 VDC	0 to 20 mA or 4 to 20 mA	0 to 5 VDC, 1 to 5 VDC, 0 to 10 VDC, or -10 to 10 VDC	0 to 20 mA or 4 to 20 mA
Max. rated input		±15 V	±30 mA	±15 V	±30 mA
External input impedance		1 MΩ min.	Approx. 250 Ω	1 MΩ min.	Approx. 250 Ω
Resolution		1/6000 (full scale)		1/12000 (full scale)	
Overall accuracy	25°C	0.3% full scale	0.4% full scale	0.2% full scale	0.3% full scale
	0 to 55°C	0.6% full scale	0.8% full scale	0.5% full scale	0.7% full scale
A/D conversion data		16-bit binary (4-digit hexadecimal) Full scale for -10 to 10 V: F448 to 0BB8 Hex Full scale for other ranges: 0000 to 1770 Hex		16-bit binary (4-digit hexadecimal) Full scale for -10 to 10 V: E890 to 1770 Hex Full scale for other ranges: 0000 to 2EE0 Hex	
Averaging function		Supported (Set in output words n+1 and n+2.)			
Open-circuit detection function		Supported			
Conversion time		2 ms/point (8 ms/all points)		1 ms/point (4 ms/all points)	
Isolation method		Photocoupler isolation between analog I/O terminals and internal circuits. No isolation between analog I/O signals.			
Current consumption		5 VDC: 100 mA max.; 24 VDC: 90 mA max.		5 VDC: 100 mA max.; 24 VDC: 50 mA max.	

### ● Analog Output Units

Model		CP1W-DA021/CP1W-DA041		CP1W-DA042		
Item		Voltage Output	Current Output	Voltage Output	Current Output	
Analog output section	Number of outputs	CP1W-DA021: 2 outputs (2 words allocated) CP1W-DA041: 4 outputs (4 words allocated)		4 outputs (4 words allocated)		
	Output signal range	1 to 5 VDC, 0 to 10 VDC, or -10 to 10 VDC	0 to 20 mA or 4 to 20 mA	1 to 5 VDC, 0 to 10 VDC, or -10 to 10 VDC	0 to 20 mA or 4 to 20 mA	
	External output allowable load resistance	2 kΩ min.	350 Ω max.	2 kΩ min.	350 Ω max.	
	External output impedance	0.5 Ω max.	---	0.5 Ω max.	---	
	Resolution	1/6000 (full scale)		1/12000 (full scale)		
	Overall accuracy	25°C	0.4% full scale		0.3% full scale	
		0 to 55°C	0.8% full scale		0.7% full scale	
D/A conversion data		16-bit binary (4-digit hexadecimal) Full scale for -10 to 10 V: F448 to 0BB8 Hex Full scale for other ranges: 0000 to 1770 Hex		16-bit binary (4-digit hexadecimal) Full scale for -10 to 10 V: E890 to 1770 Hex Full scale for other ranges: 0000 to 2EE0 Hex		
Conversion time		CP1W-DA021: 2 ms/point (4 ms/all points) CP1W-DA041: 2 ms/point (8 ms/all points)		1 ms/point (4 ms/all points)		
Isolation method		Photocoupler isolation between analog I/O terminals and internal circuits. No isolation between analog I/O signals.				
Current consumption		CP1W-DA021: 5 VDC: 40 mA max.; 24 VDC: 95 mA max. CP1W-DA041: 5 VDC: 80 mA max.; 24 VDC: 124 mA max.		5 VDC: 70 mA max.; 24 VDC: 160 mA max.		

## ● Analog I/O Units

Model		CP1W-MAD42/CP1W-MAD44		CP1W-MAD11		
Item		Voltage I/O	Current I/O	Voltage I/O	Current I/O	
Analog Input Section	Number of inputs	4 inputs (4 words allocated)		2 inputs (2 words allocated)		
	Input signal range	0 to 5 VDC, 1 to 5 VDC, 0 to 10 VDC, or -10 to 10 VDC	0 to 20 mA or 4 to 20 mA	0 to 5 VDC, 1 to 5 VDC, 0 to 10 VDC, or -10 to 10 VDC	0 to 20 mA or 4 to 20 mA	
	Max. rated input	±15 V	±30 mA	±15 V	±30 mA	
	External input impedance	1 MΩ min.	Approx. 250 Ω	1 MΩ min.	Approx. 250 Ω	
	Resolution	1/12000 (full scale)		1/6000 (full scale)		
	Overall accuracy	25°C	0.2% full scale	0.3% full scale	0.3% full scale	0.4% full scale
		0 to 55°C	0.5% full scale	0.7% full scale	0.6% full scale	0.8% full scale
	A/D conversion data	16-bit binary (4-digit hexadecimal) Full scale for -10 to 10 V: E890 to 1770 hex Full scale for other ranges: 0000 to 2EE0 hex		16-bit binary (4-digit hexadecimal) Full scale for -10 to 10 V: F448 to 0BB8 hex Full scale for other ranges: 0000 to 1770 hex		
	Averaging function	Supported		Supported (Settable for individual inputs via DIP switch)		
Open-circuit detection function	Supported					
Analog Output Section	Number of outputs	CP1W-MAD42: 2 outputs (2 words allocated) CP1W-MAD44: 4 outputs (4 words allocated)		1 output (1 word allocated)		
	Output signal range	1 to 5 VDC, 0 to 10 VDC, or -10 to 10 VDC	0 to 20 mA or 4 to 20 mA	1 to 5 VDC, 0 to 10 VDC, or -10 to 10 VDC	0 to 20 mA or 4 to 20 mA	
	Allowable external output load resistance	2 kΩ min.	350 Ω max.	1 kΩ min.	600 Ω max.	
	External output impedance	0.5 Ω max.	---	0.5 Ω max.	---	
	Resolution	1/12000 (full scale)		1/6000 (full scale)		
	Overall accuracy	25°C	0.3% full scale		0.4% full scale	
		0 to 55°C	0.7% full scale		0.8% full scale	
Set data (D/A conversion)	16-bit binary (4-digit hexadecimal) Full scale for -10 to 10 V: E890 to 1770 hex Full scale for other ranges: 0000 to 2EE0 hex		16-bit binary (4-digit hexadecimal) Full scale for -10 to 10 V: F448 to 0BB8 hex Full scale for other ranges: 0000 to 1770 hex			
Conversion time	CP1W-MAD42: 1 ms/point (6 ms/all points) CP1W-MAD44: 1 ms/point (8 ms/all points)		2 ms/point (6 ms/all points)			
Isolation method	Photocoupler isolation between analog I/O terminals and internal circuits. No isolation between analog I/O signals.					
Current consumption	CP1W-MAD42: 5 VDC: 120 mA max., 24 VDC: 120 mA max. CP1W-MAD44: 5 VDC: 120 mA max., 24 VDC: 170 mA max.		5 VDC: 83 mA max., 24 VDC: 110 mA max.			

## ■ Temperature Sensor Units: CP1W-TS001/TS002/TS003/TS004/TS101/TS102

By mounting a Temperature Sensor Unit to the PLC, inputs can be obtained from thermocouples or platinum resistance thermometers, and temperature measurements can be converted to binary data (4-digit hexadecimal) and stored in the input area of the CPU Unit.

Item	CP1W-TS001	CP1W-TS002	CP1W-TS101	CP1W-TS102
	Thermocouples		Platinum resistance thermometer	
Temperature sensors	Switchable between K and J, but same type must be used for all inputs.		Switchable between Pt100 and JPt100, but same type must be used for all inputs.	
Number of inputs	2	4	2	4
Allocated input words	2	4	2	4
Accuracy	(The larger of $\pm 0.5\%$ of converted value or $\pm 2^\circ\text{C}$ ) $\pm 1$ digit max. *		(The larger of $\pm 0.5\%$ of converted value or $\pm 1^\circ\text{C}$ ) $\pm 1$ digit max.	
Conversion time	250 ms for 2 or 4 input points			
Converted temperature data	16-bit binary data (4-digit hexadecimal)			
Isolation	Photocouplers between all temperature input signals			
Current consumption	5 VDC: 40 mA max., 24 VDC: 59 mA max.		5 VDC: 54 mA max., 24 VDC: 73 mA max.	

\* Accuracy for a K-type sensor at  $-100^\circ\text{C}$  or less is  $\pm 4^\circ\text{C} \pm 1$  digit max.

The rotary switch is used to set the temperature range.

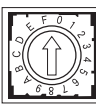
Setting	CP1W-TS001/TS002			CP1W-TS101/TS102			
	Input type	Range ( $^\circ\text{C}$ )	Range ( $^\circ\text{F}$ )	Input type	Range ( $^\circ\text{C}$ )	Range ( $^\circ\text{F}$ )	
	0	K	-200 to 1,300	-300 to 2,300	Pt100	-200.0 to 650.0	-300.0 to 1,200.0
	1		0.0 to 500.0	0.0 to 900.0	JPt100	-200.0 to 650.0	-300.0 to 1,200.0
	2	J	-100 to 850	-100 to 1,500	---	Cannot be set.	
	3		0.0 to 400.0	0.0 to 750.0	---		
4 to F	---	Cannot be set.		---			

## ● Main Specifications

Item		CP1W-TS003
Temperature sensors		Thermocouples or analog input *1
		Switchable between K and J, but same type must be used for all inputs.
Number of inputs		Thermocouples inputs :4 , Analog inputs :2 Two analog inputs can be shared with thermocouples inputs.
Accuracy at 25°C	Thermocouple inputs	(The larger of $\pm 0.5\%$ of converted value or $\pm 2^\circ\text{C}$ ) $\pm 1$ digit max. *2
	Analog voltage inputs	0.5% full scale
	Analog inputs	0.6% full scale
Accuracy at 0 to 55°C	Thermocouple inputs	(The larger of $\pm 1\%$ of converted value or $\pm 4^\circ\text{C}$ ) $\pm 1$ digit max. *3
	Analog voltage inputs	1.0 % full scale
	Analog inputs	1.2 % full scale
Input signal range	Thermocouple inputs	K: -200.0 to 1300.0°C or .300.0 to 2300.0°F J: -100.0 to 850.0°C or .100.0 to 1500.0°F
	Analog voltage inputs	0 to 10V/1 to 5V
	Analog inputs	4 to 20mA
Resolution	Thermocouple inputs	0.1°C or 0.1°F
	Analog inputs	1/12000 (full scale)
Max. rated input	Analog voltage inputs	$\pm 15\text{V}$
	Analog inputs	$\pm 30\text{mA}$
External input impedance	Analog voltage inputs	1M $\Omega$ min.
	Analog inputs	Approx. 250 $\Omega$
Open-circuit detection function		Supported
Averaging function		Unsupported
Conversion time		250 ms for 4 input points
Converted temperature data		16-bit binary data (4-digit hexadecimal)
Converted AD data		16-bit binary data (4-digit hexadecimal)
Isolation		Photocouplers between all temperature and analog input signals
Current consumption		5 VDC: 70 mA max., 24 VDC: 30 mA max.

\*1 Only last two channels can be used as analog input.

\*2 Accuracy for a K-type sensor at -100°C or less is  $\pm 4^\circ\text{C} \pm 1$  digit max.

\*3 Accuracy for a K-type sensor at -100°C or less is  $\pm 10^\circ\text{C} \pm 1$  digit max.

## DIP Switch Settings

The DIP switch is used to set the input type (temperature or analog input), the input thermocouple type (K or J) and the temperature unit (°C or °F).

**Note:** Set the temperature range according to the type of temperature sensor connected to the Unit. Temperature data will not be converted correctly if the temperature range does not match the sensor.

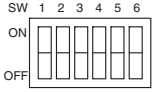
SW		Setting		
	1	Thermocouple type of temperature sensor	ON	J
			OFF	K
	2	Temperature unit	ON	°F
			OFF	°C
	3	NC		
	4	Input type selection for the third input (Input 2)	ON	Analog input
			OFF	Thermocouple
	5	Input type selection for the fourth input (Input 3)	ON	Analog input
			OFF	Thermocouple
	6	Analog input signal range	ON	1 to 5V/4 to 20mA
			OFF	0 to 10V

Temperature input		
Input type	Range (°C)	Range (°F)
K	-200.0 to 1300.0	-300 to 2300
J	-100.0 to 850.0	-100.0 to 1500

# CP1H

## ● Main Specifications

Item		CP1W-TS004
Temperature sensors		Thermocouples Switchable between K and J, but same type must be used for all inputs.
Number of inputs		12
Accuracy	25°C	(The larger of ±0.5% of converted value or ±2°C) ±1 digit max. *1
	0 to 55°C	(The larger of ±1% of converted value or ±4°C) ±1 digit max. *2
Conversion time		500 ms for 12 input points
Converted temperature data		16-bit binary data (4-digit hexadecimal)
Isolation		Photocouplers between all temperature and analog input signals
Current consumption		5 VDC: 80 mA max., 24 VDC: 50 mA max.

\*1 Accuracy for a K-type sensor at -100°C or less is ±4°C ±1 digit max.

\*2 Accuracy for a K-type sensor at -100°C or less is ±10°C ±1 digit max.

## DIP Switch Settings

The DIP switch is used to set the temperature unit and to set the temperature input range.

**Note:** Set the temperature range according to the type of temperature sensor connected to the Unit. Temperature data will not be converted correctly if the temperature range does not match the sensor.

SW	Setting		
	1	Input type	ON J
		OFF K	
	2	Temperature unit	ON °F
			OFF °C

Temperature input		
Input type	Range (°C)	Range (°F)
K	-200.0 to 1300.0	-300 to 2300
J	-100.0 to 850.0	-100.0 to 1500

## ■ CP1W-SRT21 CompoBus/S I/O Link Unit

The CompoBus/S I/O Link Unit functions as a slave for a CompoBus/S Master Unit (or an SRM1 CompoBus/S Master Control Unit) to form an I/O Link with 8 inputs and 8 outputs between the CompoBus/S I/O Link Unit and the Master Unit.

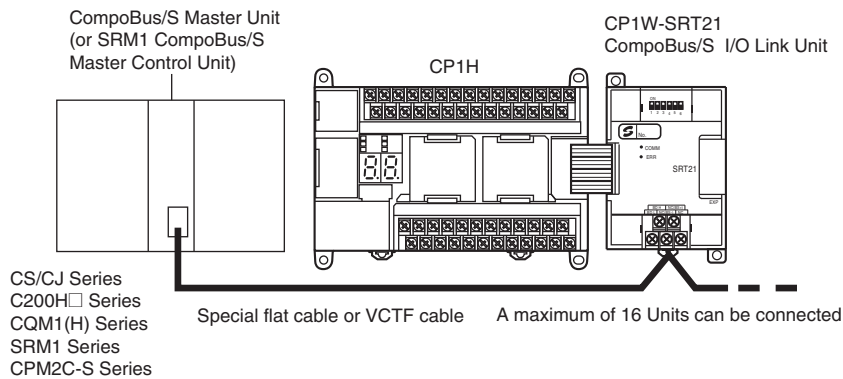

## ● Specifications

Item	Model	CP1W-SRT21
Master/Slave		CompoBus/S Slave
Number of I/O bits		8 input bits, 8 output bits
Number of words occupied in CP1H I/O memory		1 input word, 1 output word (Allocated in the same way as for other Expansion Units)
Node number setting		Set using the DIP switch (before the CPU Unit is turned ON.)



## I/O Bits and I/O Allocations

With CP1H CPU Units, the beginning input and output words (CIO 0 and CIO 100) are allocated by the CPU Unit one or two words at a time. I/O bits are allocated in word units in order of connection to Expansion Units and Expansion I/O Units connected to a CPU Unit.

CPU Unit	Allocated words	
	Inputs	Outputs
CP1H CPU Unit with 40 I/O points	CIO 0 and CIO 1	CIO 100 and CIO 101

**Note:** For details on the number of words allocated to Expansion Units and Expansion I/O Units, refer to *Words Allocated to CP1W Expansion Units and Expansion I/O Units* on page 26.

### ● Example: I/O Bit Allocations When Expansion Units Are Connected

CPU Unit with 40 I/O Points + Temperature Sensor Unit + Analog Output Unit + Expansion I/O Unit with 40 I/O Points

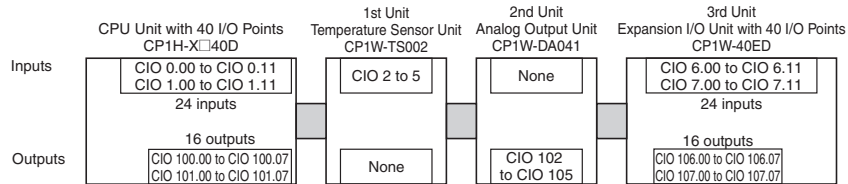

# CP1H

## Expansion Unit and Expansion I/O Units Specifications

### ■ Maximum Number of CP1W Expansion Unit and Expansion I/O Units

● CP1H CPU Unit

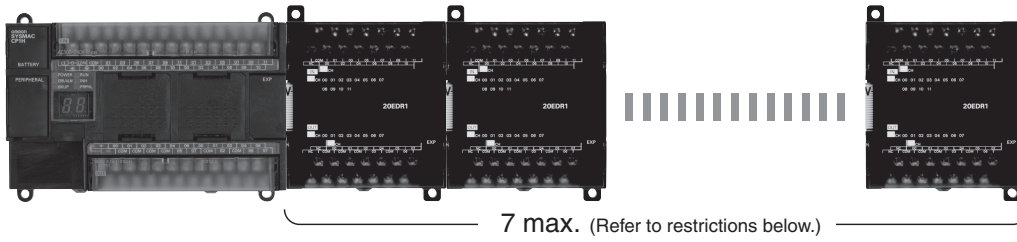

### ■ Restrictions on the Number of CP1H Expansion Unit and I/O Unit Connections

Up to seven Expansion Units and Expansion I/O Units can be connected when a CP1H CPU Unit is used, but the following restrictions apply. Observe these restrictions when using the models in the shaded areas in the following tables. A maximum total of 15 input words is allocated for Expansion Units and a maximum total of 15 output words is allocated for Expansion Units and Expansion I/O Units.

### ● Words Allocated to CP1W Expansion Units and Expansion I/O Units

Unit type	Model	No. of words		
		Input	Output	
Expansion I/O Units	40 I/O points	CP1W-40EDR	2	2
		CP1W-40EDT		
		CP1W-40EDT1		
	32 outputs	CP1W-32ER	---	4
		CP1W-32ET		
		CP1W-32ET1		
	20 I/O points	CP1W-20EDR1	1	1
		CP1W-20EDT		
		CP1W-20EDT1		
	16 outputs	CP1W-16ER	---	2
		CP1W-16ET		
		CP1W-16ET1		
	8 inputs	CP1W-8ED	1	---
		CP1W-8ER		
		CP1W-8ET		
8 outputs	CP1W-8ET1	---	1	
	CP1W-8ED			
	CP1W-8ER			
Analog Input Unit	A/D: 4 points	CP1W-AD041	4	2
		CP1W-AD042		
Analog Output Unit	DA: 2 points	CP1W-DA021	---	2
	DA: 4 points	CP1W-DA041	---	4
		CP1W-DA042		
Analog I/O Unit	A/D: 2 points D/A: 1 point	CP1W-MAD11	2	1
	A/D: 4 points D/A: 2 points	CP1W-MAD42	4	2
	A/D: 4 points D/A: 4 points	CP1W-MAD44	4	4
Temperature Sensor Unit	Thermocouple (J or K)	CP1W-TS001	2	---
		CP1W-TS002	4	
	Thermocouple (J or K)	CP1W-TS003	4	---
	Thermocouple (J or K) A/D: 2 points	CP1W-TS004	2	1
	Platinum resistance thermometer (Pt or JPt)	CP1W-TS101	2	---
CP1W-TS102		4		
CompoBus/S I/O Link Unit	8 inputs and 8 outputs	CP1W-SRT21	1	1

For example, the CP1W-TS002 Temperature Sensor Unit is allocated four words per Unit, so no more than three Units can be connected (4 words x 3 Units = 12 words). It would then be possible to mount a combination of other Units to use the remaining three input and 15 output words.

### Examples of Possible Combinations

Number of Units	Input	Output
CP1H-X40DR-A		
CP1W-TS002 x 3	4 words x 3 Units = 12 words	0 words
CP1W -TS001 x 1	2 words x 1 Unit = 2 words	0 words
CP1W -20EDR1 x 1	1 word x 1 Unit = 1 word	1 word x 1 Unit = 1 word
CP1W - DA041 x 2	0 words	4 words x 2 Units = 8 words
Total: 7 Units	Total: 15 words	Total: 9 words
≤7 Units	≤15 words	≤15 words

■ Using CP1W-CN811 I/O Connecting Cable

- I/O Connecting Cable can be connected to any Unit from the CP1H CPU Unit to the third Expansion Unit or Expansion I/O Unit (i.e., the fourth Unit).
- Only one I/O Connecting Cable can be used in each CP1H PLC.
- Even when I/O Connecting Cable is used, the above restrictions on the number of connectable CP1W Expansion Units and Expansion I/O Units still apply.

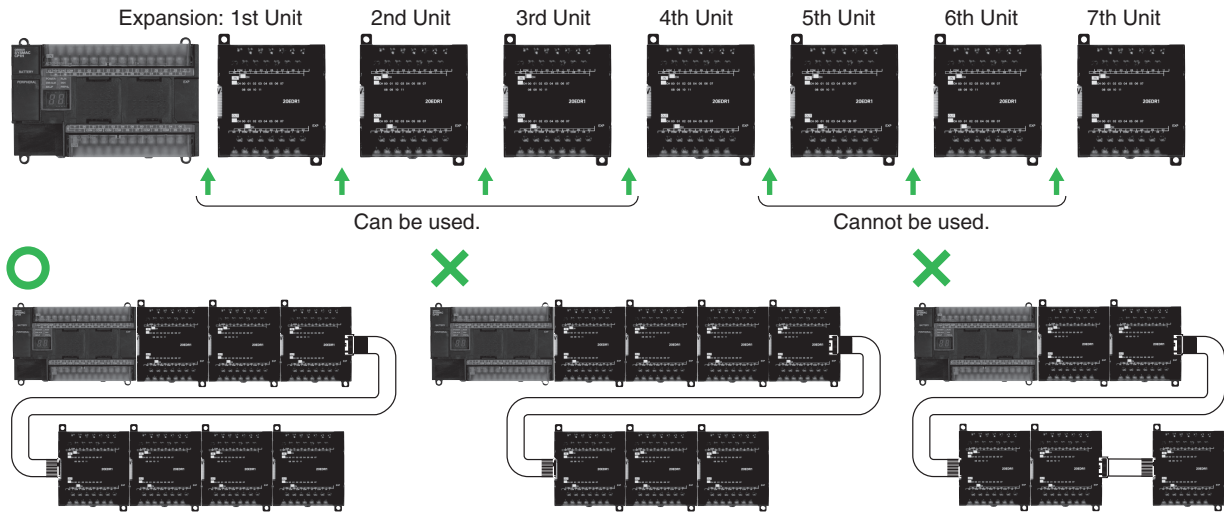

■ Using CJ-series Special I/O Units or CPU Bus Units with a CP1H CPU Unit

Up to two CJ-series Special I/O Units or CPU Bus Units can be connected by using a CP1W-EXT01 CJ Unit Adapter. The number of Units that can be used is as described below.

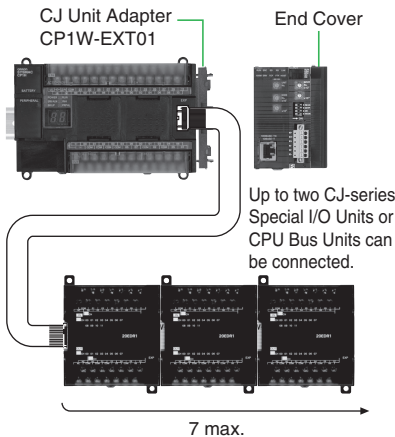

Use CP1W-CN811 I/O Connecting Cable when using CP1W Expansion Units and Expansion I/O Units at the same time as a CJ Unit Adapter. In this situation, the number of CP1W Expansion Unit and Expansion I/O Units that can be connected is subject to the restrictions described above. Only one I/O Connecting Cable can be used.

● CJ-series Special I/O Units and CPU Bus Units (For details, refer to the CJ1 Catalog (Cat. No. P052)).

Unit name	Model	5 V Current consumption (A)	Unit name	Model	5 V Current consumption (A)	
Analog Input Units	CJ1W-AD042	0.52 A	Position Control Units	CJ1W-NC113	0.25 A	
	CJ1W-AD081-V1	0.42 A		CJ1W-NC213		
	CJ1W-AD041-V1			CJ1W-NC413	0.36 A	
Analog Output Units	CJ1W-DA042V	0.40 A		CJ1W-NC133	0.25 A	
	CJ1W-DA08V	0.14 A		CJ1W-NC233		
	CJ1W-DA08C		0.12 A	CJ1W-NC433	0.36 A	
	CJ1W-DA041	0.12 A		High-speed Counter Unit	CJ1W-CT021	0.25 A
	CJ1W-DA021			ID Sensor Units	CJ1W-V680C11	0.26 A (24 VDC 0.13 A)
Analog I/O Unit	CJ1W-MAD42	0.58 A	CJ1W-V680C12			0.32 A (24 VDC 0.26 A)
	Process Input Units	CJ1W-PH41U			0.30 A	CJ1W-V600C11
CJ1W-AD04U		0.32 A	CJ1W-V600C12		0.32 A (24 VDC 0.24 A)	
CJ1W-PTS51		0.25 A			Serial Communications Units	CJ1W-SCU42
CJ1W-PTS52			0.18 A			CJ1W-SCU22
CJ1W-PTS15				CJ1W-SCU32		0.46 A
Temperature Control Units	CJ1W-PDC15	0.25 A	CJ1W-SCU41-V1	0.38 A*		
	CJ1W-TC001		CJ1W-SCU21-V1	0.28 A*		
	CJ1W-TC002		CJ1W-SCU31-V1	0.38 A		
	CJ1W-TC003		Ethernet Unit	CJ1W-ETN21	0.37 A	
	CJ1W-TC004			EtherNet/IP™ Unit	CJ1W-EIP21	0.41 A
	CJ1W-TC101				DeviceNet™ Unit	CJ1W-DRM21
CJ1W-TC102	Controller Link Unit	CJ1W-CLK23		0.35 A		
CJ1W-TC103		MECHATROLINK-II Position Control Unit	CJ1W-NC271	0.36 A		
CJ1W-TC104	CJ1W-NC471					
CompoBus/S Master Unit	CJ1W-SRM21		0.15 A		CJ1W-NCF71	
CompoNet™ Master Unit	CJ1W-CRM21	0.40 A	CJ1W-NCF71-MA	0.6 A		
			MECHATROLINK-II Motion Control Unit		CJ1W-MCH71	
			FL-net Unit	CJ1W-FLN22	0.37 A	
			High-speed Data Storage Unit	CJ1W-SPU01-V2	0.56 A	

\* The current consumption increases by 0.15 A/Adapter when NT-AL001 Link Adapters are used.

# CP1H

## Current Consumption

- Based on the current consumption when CJ-series Special I/O Units or CPU Bus Units are used with a CP1H CPU Unit, the maximum number of Units that can be used is two CJ-series Units and seven CP1W Expansion Units and Expansion I/O Units.

The current consumption for the CP1H must be no more than 2 A for 5 V and 1 A for 24 V, and the total current consumption must be no more than 30 W.

Check the total current consumption to be sure these limits are not exceeded referring to page 28 for the CP1H CPU Unit and CP1W Expansion Unit and Expansion I/O Unit current consumptions and to the above table for CJ-series Unit current consumptions.

### ● CPU Units

Model	Current consumption		External power supply
	5 VDC	24 VDC	24 VDC (See note 5.)
CP1H-X40DR-A	0.42 A	0.07 A	0.3 A max. (0.9 A max.)
CP1H-X40DT-D	0.50 A	0.01 A	---
CP1H-X40DT1-D	0.50 A	0.02 A	---
CP1H-XA40DR-A	0.43 A	0.18 A	0.3 A max. (0.8 A max.)
CP1H-XA40DT-D	0.51 A	0.12 A	---
CP1H-XA40DT1-D	0.51 A	0.15 A	---
CP1H-Y20DT-D	0.55 A	---	---

- Note:**
1. The current consumption of the CP1W-ME05M Memory Cassette and the CP1W-CIF01/CIF11 Option Boards are included in the current consumption of the CPU Unit.
  2. CPU Units with DC power do not provide an external power supply.
  3. The current consumptions given in the following table must be added to the current consumption of the CPU Unit if an Expansion Unit or Expansion I/O Unit is connected.
  4. The external power supply cannot be used if an Expansion Unit or Expansion I/O Unit is connected to a CPU Unit with 14 or 20 I/O points.
  5. Values in parentheses are the maximum external power supply for a CPU Unit to which an Expansion I/O Unit is not connected. Refer to the *CP1H CPU Unit Operation Manual* (Cat. No. W450) for details.

### ● Option Units

Unit name	Model	Current consumption	
		DC5V	24 VDC
RS-232C Option Board	CP1W-CIF01	--- *	---
RS-422A/485 Option Board	CP1W-CIF11	--- *	---
RS-422A/485 (Isolated-type) Option Board	CP1W-CIF12-V1	0.075A	---
Ethernet Option Board	CP1W-CIF41	0.130A	---
LCD Option Board	CP1W-DAM01	0.020A	---
Memory Cassette	CP1W-ME05M	--- *	---
CJ Unit Adapter	CP1W-EXT01	--- *	---

- \* The current consumption of the following is included with the current consumption of the CPU Unit:  
CP1W-ME05M Memory Cassette, CP1W-CIF01 or CP1W-CIF11 Option Board, and CP1W-EXT01 CJ Unit Adapter.

### ● Others : Equipment that uses internal power supply of PLC

Unit name	Model	Current consumption	
		5 VDC	24 VDC
Link Adapter	CJ1W-CIF11	0.04A	---
	NT-AL001	0.15A	---
Programmable Terminal NV3W-V1	Backlight (Green/Orange/Red)	0.2A	---
	Backlight (White/Pink/Red)	0.2A	---

### ● Expansion Units and Expansion I/O Units

Unit name		Model	Current consumption	
			5 VDC	24 VDC
Expansion I/O Units	40 I/O points 24 inputs 16 outputs	CP1W-40EDR	0.080 A	0.090 A
		CP1W-40EDT	0.160 A	---
		CP1W-40EDT1		
	32 outputs	CP1W-32ER	0.049 A	0.131 A
		CP1W-32ET	0.113 A	---
		CP1W-32ET1		
	20 I/O points 12 inputs 8 outputs	CP1W-20EDR1	0.103 A	0.044 A
		CP1W-20EDT	0.130 A	---
		CP1W-20EDT1		
	16 outputs	CP1W-16ER	0.042 A	0.090 A
		CP1W-16ET	0.076 A	---
		CP1W-16ET1		
	8 inputs	CP1W-8ED	0.018 A	---
	8 outputs	CP1W-8ER	0.026 A	0.044 A
		CP1W-8ET	0.075 A	---
CP1W-8ET1				
Analog Input Unit	A/D: 4 points	CP1W-AD041	0.100 A	0.090 A
		CP1W-AD042	0.100 A	0.050 A
Analog Output Unit	DA: 2 points	CP1W-DA021	0.040 A	0.095 A
	DA: 4 points	CP1W-DA041	0.080 A	0.124 A
		CP1W-DA042	0.070 A	0.160 A
Analog I/O Unit	A/D: 2 points D/A: 1 point	CP1W-MAD11	0.083 A	0.110 A
	A/D: 4 points D/A: 2 points	CP1W-MAD42	0.120 A	0.120 A
	A/D: 4 points D/A: 4 points	CP1W-MAD44	0.120 A	0.170 A
Temperature Sensor Unit	Thermocouple (J or K)	CP1W-TS001	0.040 A	0.059 A
		CP1W-TS002		
	Thermocouple (J or K)	CP1W-TS003	0.070 A	0.030 A
	Thermocouple (J or K)	CP1W-TS004	0.080 A	0.050 A
	Platinum resistance thermometer (Pt or JPt)	CP1W-TS101	0.054 A	0.073 A
CP1W-TS102				
CompoBus/S I/O Link Unit	8 inputs and 8 outputs	CP1W-SRT21	0.029 A	---

# CP1H

## Dimensions

(Unit: mm)

### ■ CPU Units

#### CP1H CPU Units (X/XA/Y Types)

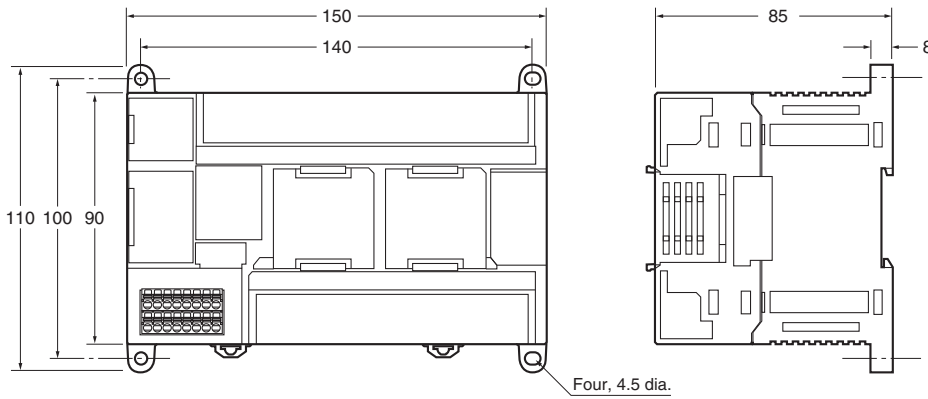

Weight:  
 CP1H-□□□-A (AC power supply):  
 740 g max.  
 CP1H-□□□-D DC power supply):  
 590 g max.

### ■ Expansion Units and Expansion I/O Units

CP1W-20ED□□, CP1W-16E□□,  
 CP1W-AD04□, CP1W-DA021/04□,  
 CP1W-MAD□□, CP1W-TS□□1/□□2/□□3

CP1W-8E□□  
 CP1W-SRT21

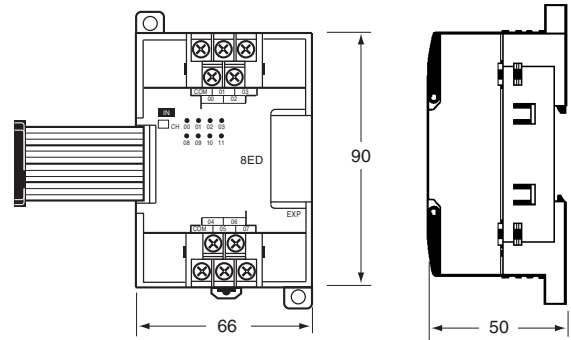
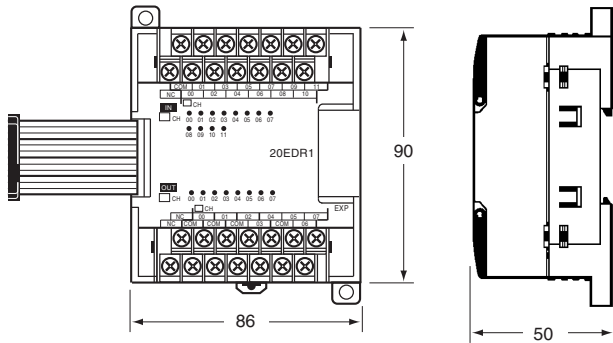

CP1W-40ED□  
 CP1W-32E□□  
 CP1W-TS004

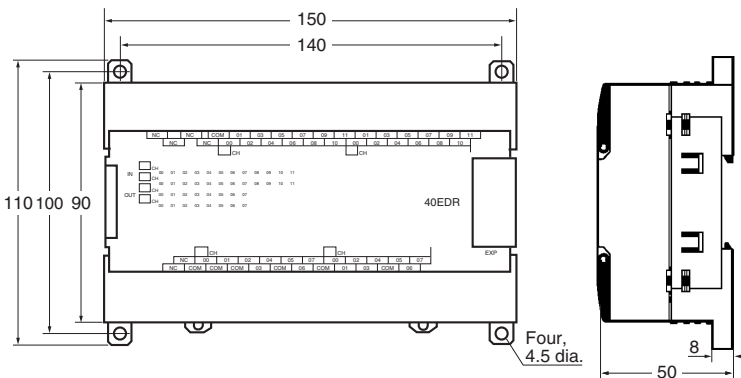

Unit name	Model number	Weight
Expansion I/O Units	CP1W-40EDR	380 g
	CP1W-40EDT/-40EDT1	320 g
	CP1W-32ER	465 g
	CP1W-32ET/-32ET1	325 g
	CP1W-20EDR1/-20EDT/-20EDT1	300 g
	CP1W-16ER	280 g
	CP1W-16ET/-16ET1	225 g
	CP1W-8ED	200 g
	CP1W-8ER/-8ET/-8ET1	250 g
	Analog Units	CP1W-AD041/-DA041/-DA021
CP1W-AD042/-DA042		250 g
CP1W-MAD11		150 g
CP1W-MAD44/-MAD42		250 g
Temperature Sensor Units	CP1W-TS001/-TS002/ -TS101/-TS102	250 g
	CP1W-TS003	240 g
	CP1W-TS004	570 g
CompoBus/S I/O Link Unit	CP1W-SRT21	200 g

■ CJ-series Special I/O Units and CPU Bus Units

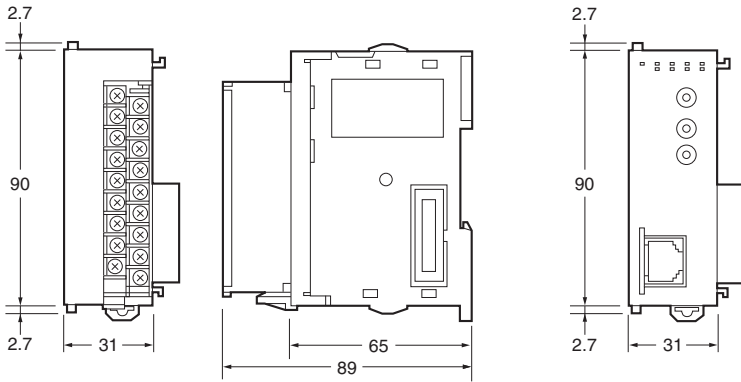

Note: It takes an example about the size.

■ CJ Unit Adaptor  
CP1W-EXT01

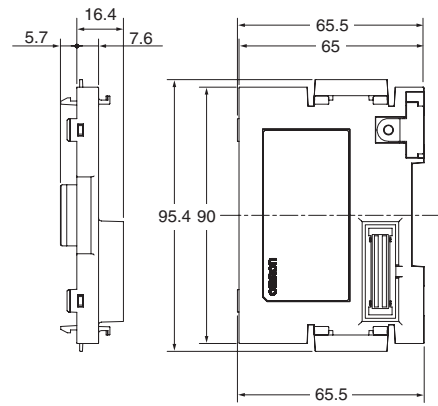

■ CP1H

Example: Two CJ-series Units (31-mm widths) Connected Using a CJ Unit Adaptor

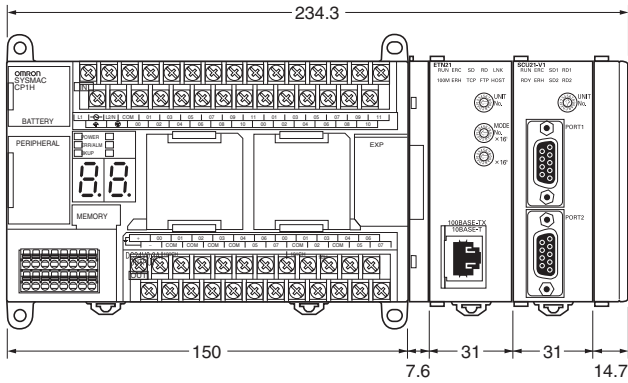

# CP1H

## Related Manuals

Cat. No.	Model numbers	Manual name	Description
W450	CP1H-X40D□-□ CP1H-XA40D□-□ CP1H-Y20DT-D	CP Series CP1H CPU Unit Operation Manual	Provides the following information on the CP Series: <ul style="list-style-type: none"> <li>• Overview, design, installation, maintenance, and other basic specifications</li> <li>• Features</li> <li>• System configuration</li> <li>• Mounting and wiring</li> <li>• I/O memory allocation</li> <li>• Troubleshooting</li> </ul> Use this manual together with the <i>CP1H Programmable Controllers Programming Manual (W451)</i> .
W451	CP1H-X40D□-□ CP1H-XA40D□-□ CP1H-Y20DT-D	CP Series CP1H CPU Unit Programming Manual	Provides the following information on the CP Series: <ul style="list-style-type: none"> <li>• Programming instructions</li> <li>• Programming methods</li> <li>• Tasks</li> <li>• File memory</li> <li>• Functions</li> </ul> Use this manual together with the <i>CP1H Programmable Controllers Operation Manual (W450)</i> .
W342	CS1G/H-CPU□□H CS1G/H-CPU□□-V1 CS1D-CPU□□HA CS1D-CPU□□SA CS1D-CPU□□H CS1D-CPU□□S CS1W-SCU21 CS1W-SCB21-V1/41-V1 CJ1G/H-CPU□□H CJ1G-CPU□□P CP1H-CPU□□ CJ1G-CPU□□ CJ1W-SCU21-V1/41-V1	CS/CJseries Communications Commands Reference Manual	Describes commands addressed to CS-series and CJ-series CPU Units, including C-mode commands and FINS commands.  <b>Note:</b> This manual describes on commands address to CPU Units regardless of the communications path. (CPU Unit serial ports, Serial Communications Unit/Board ports, and Communications Unit ports can be used.) Refer to the relevant operation manuals for information on commands addresses to Special I/O Units and CPU Bus Units.



# Terms and Conditions Agreement

## **Read and understand this catalog.**

Please read and understand this catalog before purchasing the products. Please consult your OMRON representative if you have any questions or comments.

## **Warranties.**

- (a) Exclusive Warranty. Omron's exclusive warranty is that the Products will be free from defects in materials and workmanship for a period of twelve months from the date of sale by Omron (or such other period expressed in writing by Omron). Omron disclaims all other warranties, express or implied.
- (b) Limitations. OMRON MAKES NO WARRANTY OR REPRESENTATION, EXPRESS OR IMPLIED, ABOUT NON-INFRINGEMENT, MERCHANTABILITY OR FITNESS FOR A PARTICULAR PURPOSE OF THE PRODUCTS. BUYER ACKNOWLEDGES THAT IT ALONE HAS DETERMINED THAT THE PRODUCTS WILL SUITABLY MEET THE REQUIREMENTS OF THEIR INTENDED USE.

Omron further disclaims all warranties and responsibility of any type for claims or expenses based on infringement by the Products or otherwise of any intellectual property right. (c) Buyer Remedy. Omron's sole obligation hereunder shall be, at Omron's election, to (i) replace (in the form originally shipped with Buyer responsible for labor charges for removal or replacement thereof) the non-complying Product, (ii) repair the non-complying Product, or (iii) repay or credit Buyer an amount equal to the purchase price of the non-complying Product; provided that in no event shall Omron be responsible for warranty, repair, indemnity or any other claims or expenses regarding the Products unless Omron's analysis confirms that the Products were properly handled, stored, installed and maintained and not subject to contamination, abuse, misuse or inappropriate modification. Return of any Products by Buyer must be approved in writing by Omron before shipment. Omron Companies shall not be liable for the suitability or unsuitability or the results from the use of Products in combination with any electrical or electronic components, circuits, system assemblies or any other materials or substances or environments. Any advice, recommendations or information given orally or in writing, are not to be construed as an amendment or addition to the above warranty.

See <http://www.omron.com/global/> or contact your Omron representative for published information.

## **Limitation on Liability; Etc.**

OMRON COMPANIES SHALL NOT BE LIABLE FOR SPECIAL, INDIRECT, INCIDENTAL, OR CONSEQUENTIAL DAMAGES, LOSS OF PROFITS OR PRODUCTION OR COMMERCIAL LOSS IN ANY WAY CONNECTED WITH THE PRODUCTS, WHETHER SUCH CLAIM IS BASED IN CONTRACT, WARRANTY, NEGLIGENCE OR STRICT LIABILITY.

Further, in no event shall liability of Omron Companies exceed the individual price of the Product on which liability is asserted.

## **Suitability of Use.**

Omron Companies shall not be responsible for conformity with any standards, codes or regulations which apply to the combination of the Product in the Buyer's application or use of the Product. At Buyer's request, Omron will provide applicable third party certification documents identifying ratings and limitations of use which apply to the Product. This information by itself is not sufficient for a complete determination of the suitability of the Product in combination with the end product, machine, system, or other application or use. Buyer shall be solely responsible for determining appropriateness of the particular Product with respect to Buyer's application, product or system. Buyer shall take application responsibility in all cases.

NEVER USE THE PRODUCT FOR AN APPLICATION INVOLVING SERIOUS RISK TO LIFE OR PROPERTY OR IN LARGE QUANTITIES WITHOUT ENSURING THAT THE SYSTEM AS A WHOLE HAS BEEN DESIGNED TO ADDRESS THE RISKS, AND THAT THE OMRON PRODUCT(S) IS PROPERLY RATED AND INSTALLED FOR THE INTENDED USE WITHIN THE OVERALL EQUIPMENT OR SYSTEM.

## **Programmable Products.**

Omron Companies shall not be responsible for the user's programming of a programmable Product, or any consequence thereof.

## **Performance Data.**

Data presented in Omron Company websites, catalogs and other materials is provided as a guide for the user in determining suitability and does not constitute a warranty. It may represent the result of Omron's test conditions, and the user must correlate it to actual application requirements. Actual performance is subject to the Omron's Warranty and Limitations of Liability.

## **Change in Specifications.**

Product specifications and accessories may be changed at any time based on improvements and other reasons. It is our practice to change part numbers when published ratings or features are changed, or when significant construction changes are made. However, some specifications of the Product may be changed without any notice. When in doubt, special part numbers may be assigned to fix or establish key specifications for your application. Please consult with your Omron's representative at any time to confirm actual specifications of purchased Product.

## **Errors and Omissions.**

Information presented by Omron Companies has been checked and is believed to be accurate; however, no responsibility is assumed for clerical, typographical or proofreading errors or omissions.

**Note: Do not use this document to operate the Unit.**

**OMRON Corporation Industrial Automation Company**  
Tokyo, JAPAN

**Contact: [www.ia.omron.com](http://www.ia.omron.com)**

**Regional Headquarters**

**OMRON EUROPE B.V.**

Wegalaan 67-69-2132 JD Hoofddorp  
The Netherlands  
Tel: (31)2356-81-300/Fax: (31)2356-81-388

**OMRON ELECTRONICS LLC**

One Commerce Drive Schaumburg,  
IL 60173-5302 U.S.A.  
Tel: (1) 847-843-7900/Fax: (1) 847-843-7787

**OMRON ASIA PACIFIC PTE. LTD.**

No. 438A Alexandra Road # 05-05/08 (Lobby 2),  
Alexandra Technopark,  
Singapore 119967  
Tel: (65) 6835-3011/Fax: (65) 6835-2711

**OMRON (CHINA) CO., LTD.**

Room 2211, Bank of China Tower,  
200 Yin Cheng Zhong Road,  
PuDong New Area, Shanghai, 200120, China  
Tel: (86) 21-5037-2222/Fax: (86) 21-5037-2200

**Authorized Distributor:**

© OMRON Corporation 2012-2017 All Rights Reserved.  
In the interest of product improvement,  
specifications are subject to change without notice.

CSM\_11\_7\_1118  
Cat. No. P080-E1-03

Printed in Japan  
1117 (0312)