

A

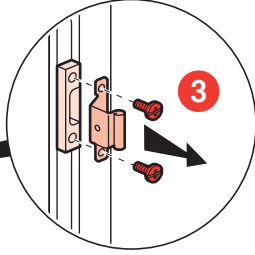

2

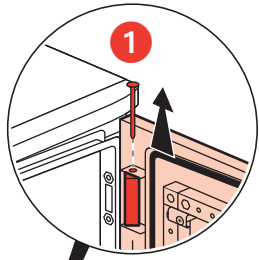
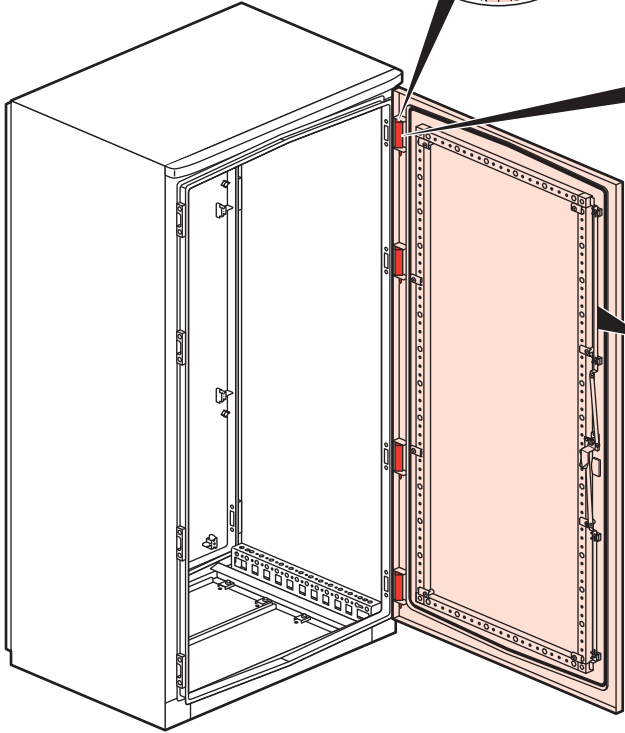
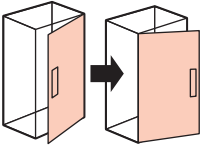
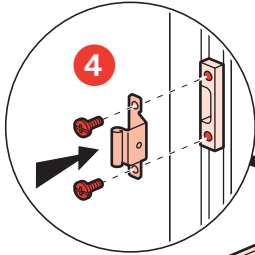
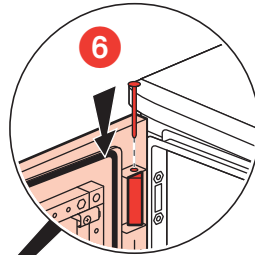

5

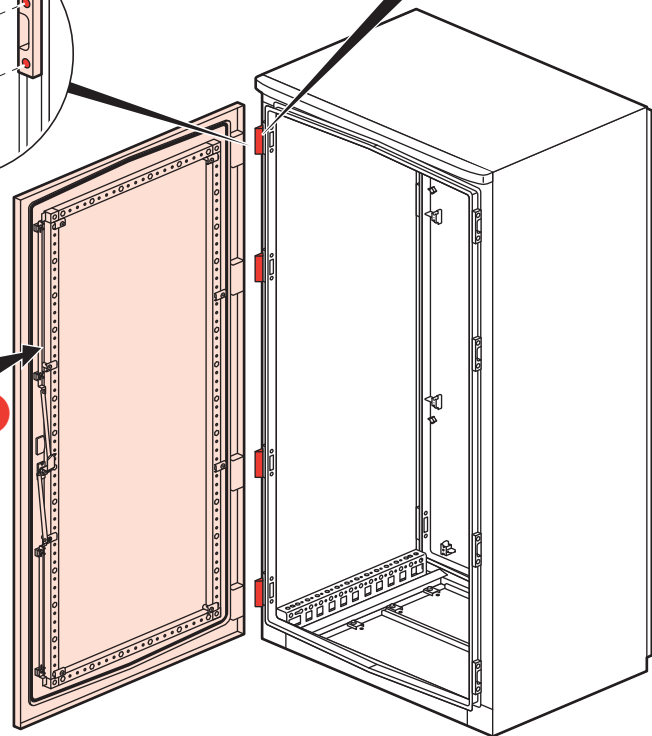

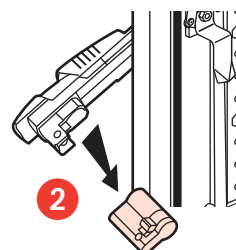
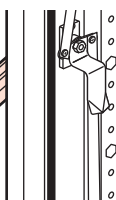
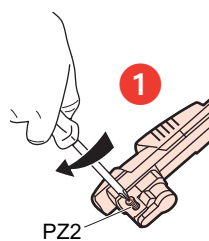
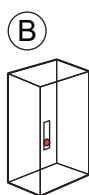
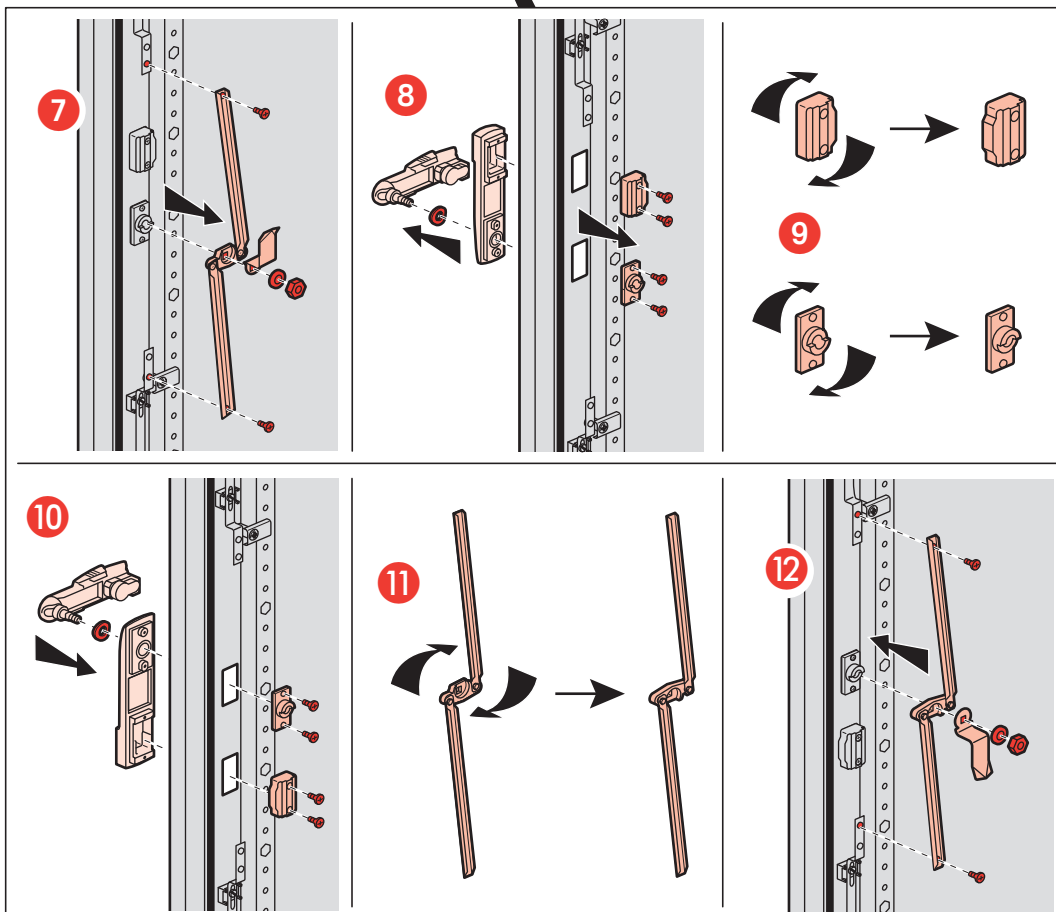
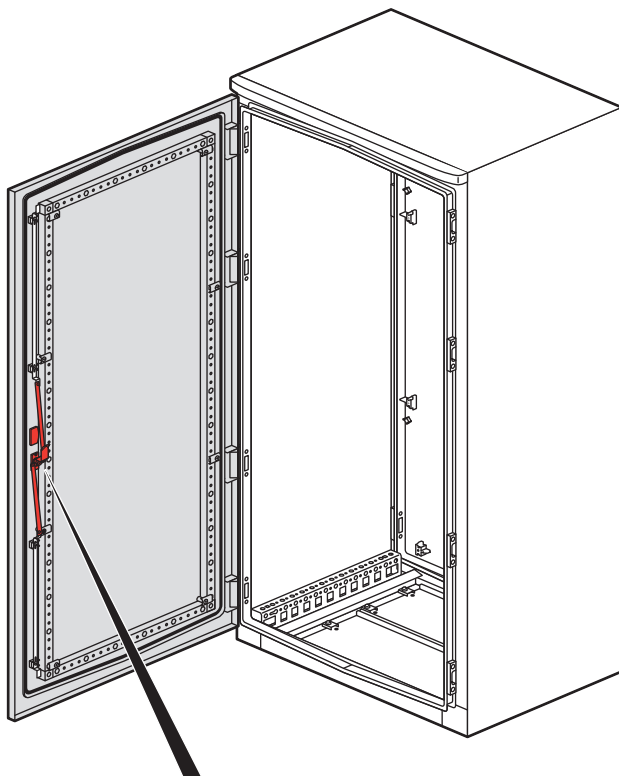
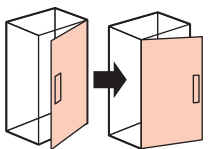

C

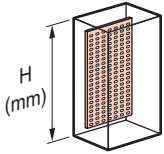
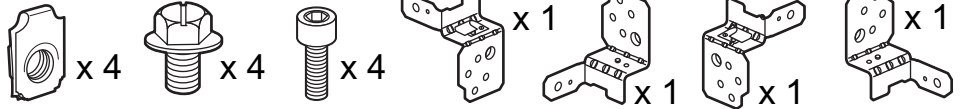
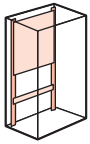

H = 1400	H = 1600	H = 1800

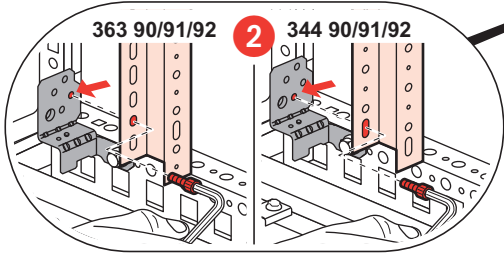
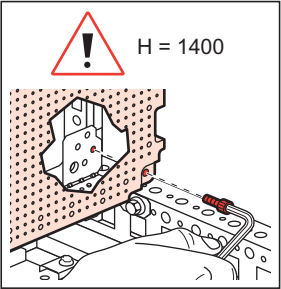
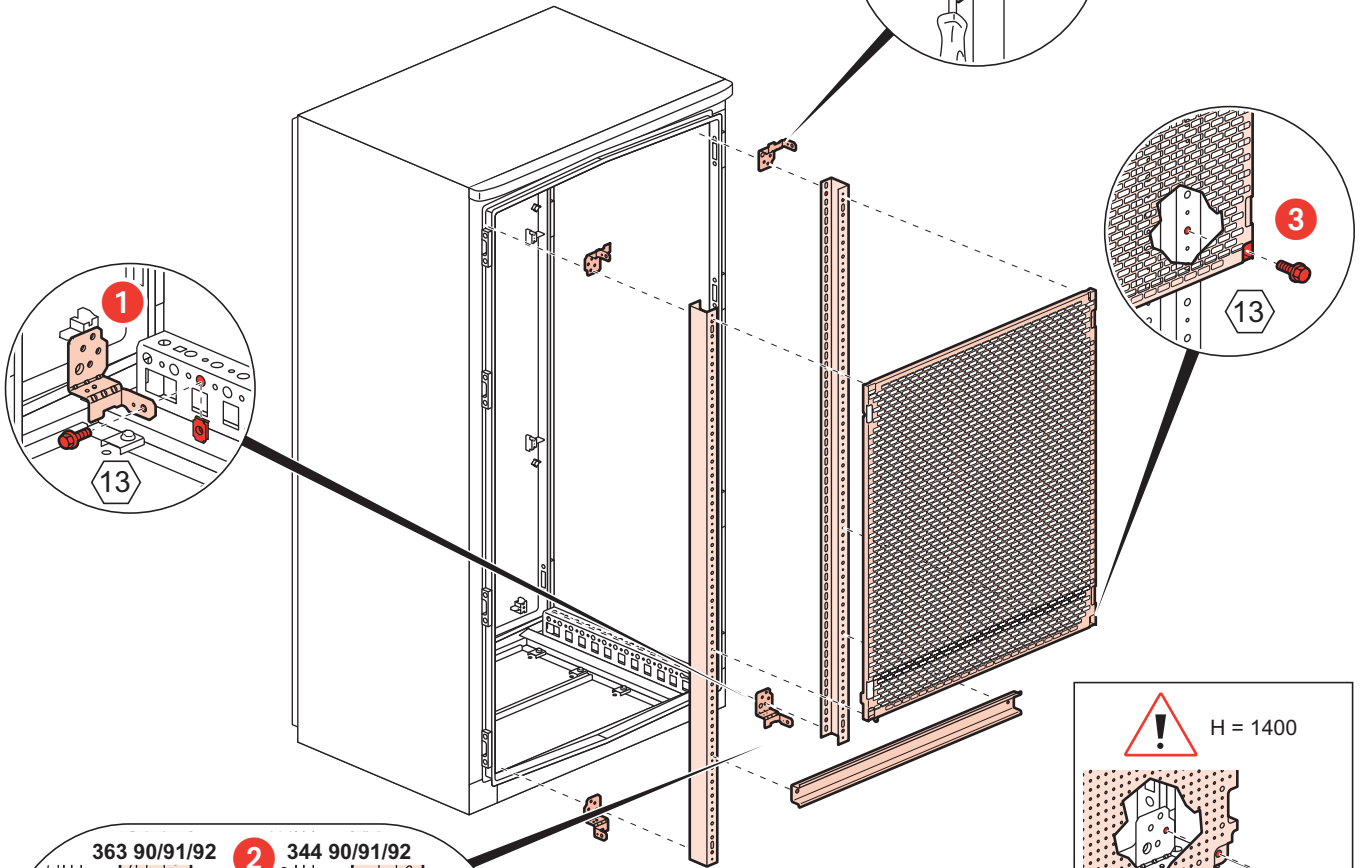

Lina 12,5

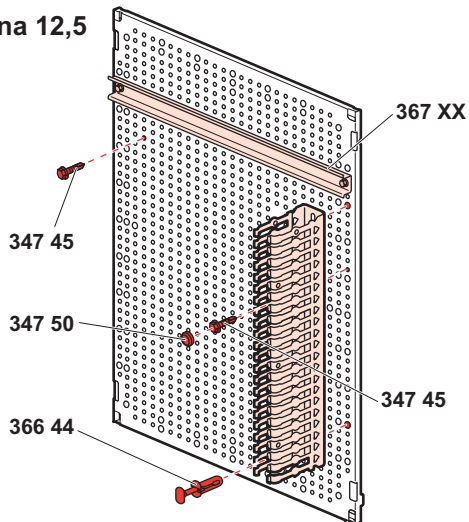

D

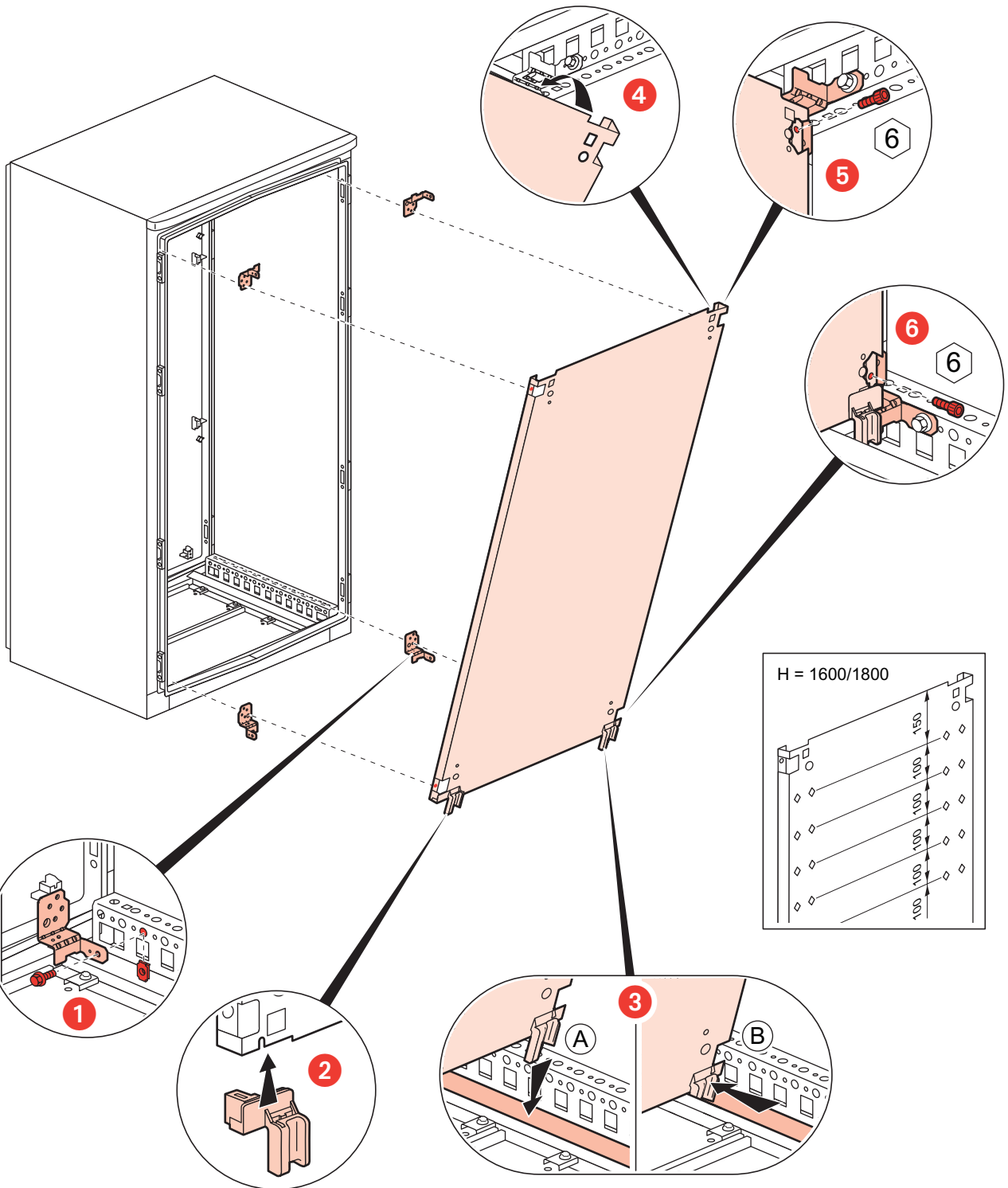
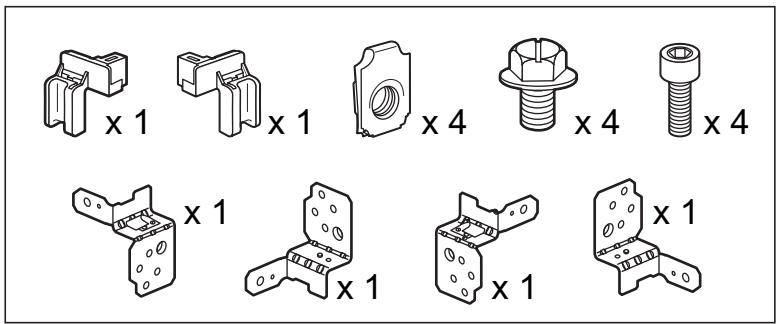
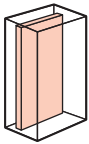

E

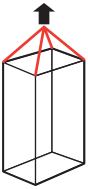

362 46



x 4



x 4



x 4



x 4

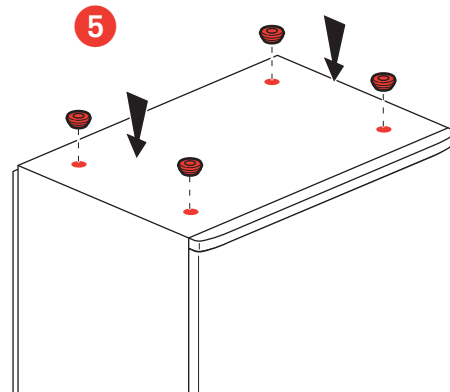
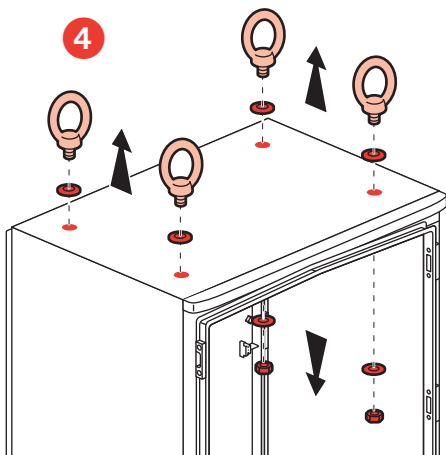
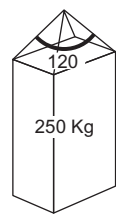
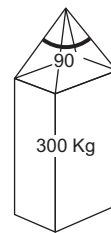
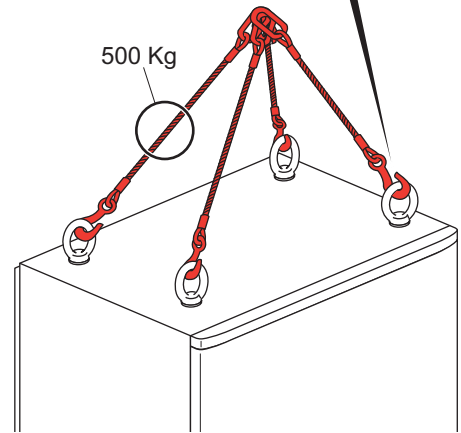
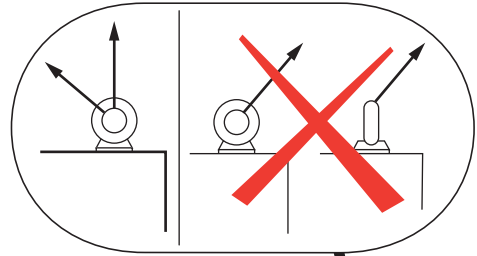
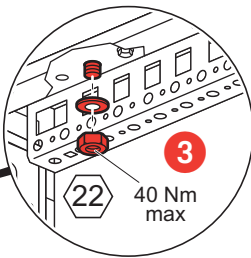
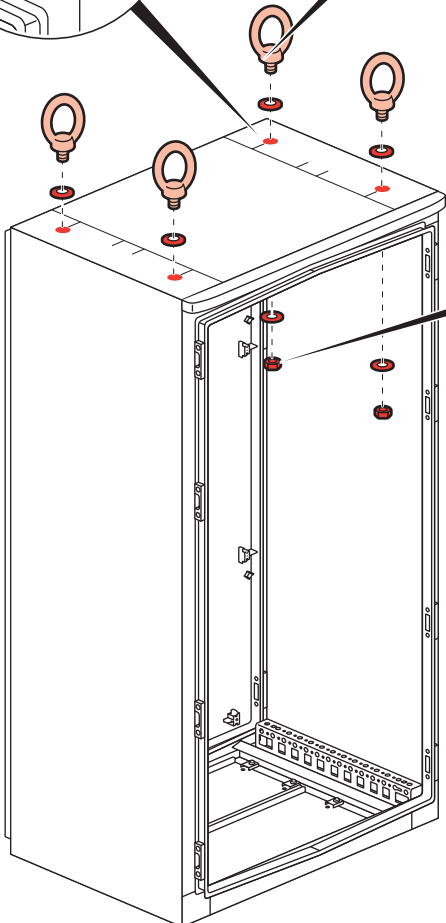
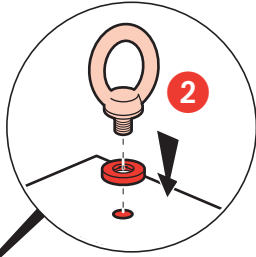
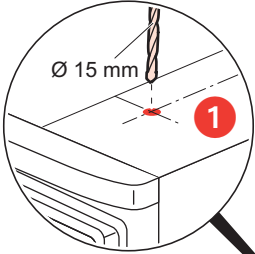

F

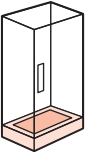

362 96

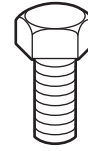
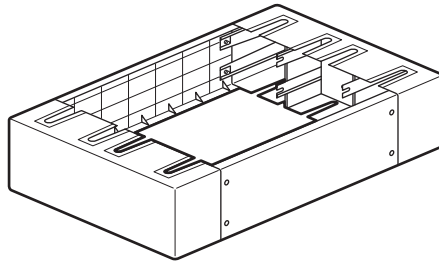

x 4



x 4



x 8

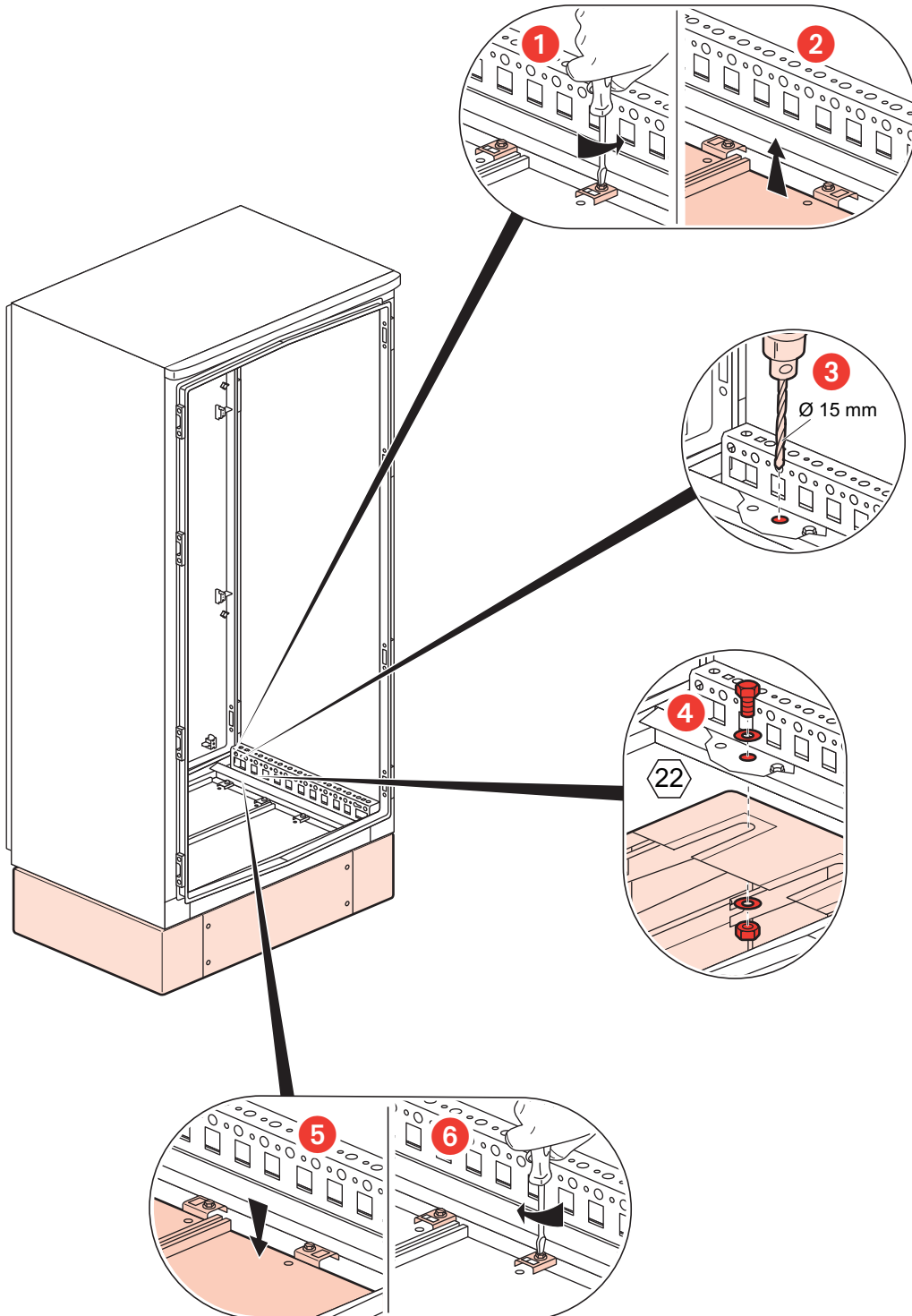

F<sub>1</sub>

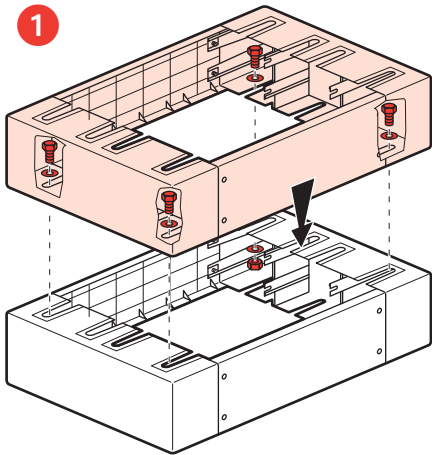
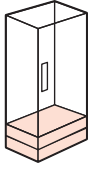

2

