

Micro800 Programmable Controller Family



Bulletin 2080
Selection Guide



LISTEN.
THINK.
SOLVE.

 Allen-Bradley • Rockwell Software

**Rockwell
Automation**

Important User Information

Solid state equipment has operational characteristics differing from those of electromechanical equipment. Safety Guidelines for the Application, Installation and Maintenance of Solid State Controls (publication [SGI-1.1](#) available from your local Rockwell Automation sales office or online at <http://rockwellautomation.com/literature>) describes some important differences between solid state equipment and hard-wired electromechanical devices. Because of this difference, and also because of the wide variety of uses for solid state equipment, all persons responsible for applying this equipment must satisfy themselves that each intended application of this equipment is acceptable.





In no event will Rockwell Automation, Inc. be responsible or liable for indirect or consequential damages resulting from the use or application of this equipment.

The examples and diagrams in this manual are included solely for illustrative purposes. Because of the many variables and requirements associated with any particular installation, Rockwell Automation, Inc. cannot assume responsibility or liability for actual use based on the examples and diagrams.

No patent liability is assumed by Rockwell Automation, Inc. with respect to use of information, circuits, equipment, or software described in this manual.

Reproduction of the contents of this manual, in whole or in part, without written permission of Rockwell Automation, Inc., is prohibited.

Throughout this manual, when necessary, we use notes to make you aware of safety considerations.

WARNING 	Identifies information about practices or circumstances that can cause an explosion in a hazardous environment, which may lead to personal injury or death, property damage, or economic loss.
IMPORTANT	Identifies information that is critical for successful application and understanding of the product.
ATTENTION 	Identifies information about practices or circumstances that can lead to: personal injury or death, property damage, or economic loss. Attentions help you identify a hazard, avoid a hazard, and recognize the consequence.
SHOCK HAZARD 	Labels may be on or inside the equipment, such as a drive or motor, to alert people that dangerous voltage may be present.
BURN HAZARD 	Labels may be on or inside the equipment, such as a drive or motor, to alert people that surfaces may reach dangerous temperatures.

Allen-Bradley, Rockwell Automation, Micro800, Micro810, Micro820, Micro830, Micro850, Connected Components Workbench, FactoryTalk, PowerFlex, CompactBlock, and TechConnect are trademarks of Rockwell Automation, Inc.

Trademarks not belonging to Rockwell Automation are property of their respective companies.

Select a Micro800 Controller



Micro800™ controllers are designed for low-cost, standalone machines. These economical small-size PLCs are available in different form factors based on the number of I/O points embedded in the base, with a range of features intended to address different requirements. The Micro800 family shares programming environment, accessories and plug-ins that allow machine builders to personalize the controller for specific capabilities.

Micro810™ controllers function as a smart relay with high current relay outputs, but with the programming capabilities of a micro PLC. The Micro810 controllers come in a 12-point form factor.

Micro820™ controllers are specifically designed for smaller standalone machines and remote automation projects. It has embedded Ethernet and serial ports and a microSD™ slot for datalogging and recipe management. These controllers come as 20-point form factors that can accommodate up to two plug-in modules. It also supports the Micro800 Remote LCD (2080-REMLCD) module to allow easier configuration of such settings as IP address and functions as a simple IP65 text display.

Micro830™ controllers are designed for standalone machine control applications. They have flexible communications and I/O capabilities with up to five plug-ins. They come as a 10-, 16-, 24-, or 48-point form factors.

Micro850™ expandable controllers are designed for applications that require more digital and analog I/O or higher performance analog I/O. They can support up to four expansion I/O. Micro850 controllers include additional communication connection options through an embedded 10/100 Base-T Ethernet port.

Several Micro830 and Micro850 controllers support basic positioning through embedded pulse train outputs (PTO). These controllers also allow you to configure up to six high speed counters (HSC), and choose from nine HSC operation modes. HSC is supported on all Micro830 and Micro850 catalogs, except on 2080-LCxx-xxAWB. PTO is only supported on Micro830 and Micro850 catalog numbers that end in BB or VB.

This selection guide serves to help you identify the right controller, plug-ins, expansion I/O, and accessories, based on your requirements.

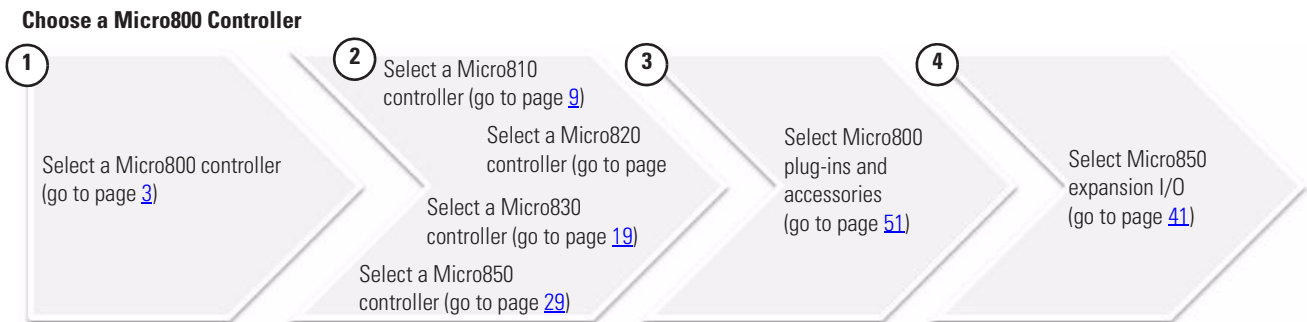

Micro800 Controllers Comparison

Features

Attribute	Micro810	Micro820	Micro830				Micro850	
	12-point	20-point	10-point	16-point	24-point	48-point	24-point	48-point
Communication ports, embedded	USB 2.0 (with USB adapter)	10/100 Base T Ethernet port (RJ-45) RS232/RS485 non-isolated combo serial	USB 2.0 (non-isolated) RS232/RS485 non-isolated combo serial				USB 2.0 (non-isolated) RS232/RS485 non-isolated combo serial 10/100 Base T Ethernet port (RJ-45)	
Embedded digital I/O points ⁽¹⁾	12	19	10	16	24	48	24	48
Base analog I/O channels	Four 24V DC digital inputs are shared as 0...10V analog inputs (DC input models only)	One 0...10V analog output Four 24V DC digital inputs can be configured as 0...10V analog inputs (DC input models only) and via plug-in modules	Via plug-in modules				Via plug-in modules and expansion I/O	
Number of plug-in modules	0	2	2	2	3	5	3	5
Maximum digital I/O ⁽²⁾	12	35	26	32	48	88	132	
Types of accessories or plug-ins supported	<ul style="list-style-type: none"> LCD display with backup memory module USB adapter 	<ul style="list-style-type: none"> Micro800 Remote LCD (2080-REMLCD) All-plug-in modules except 2080-MEMBAK-RTC (see page 51) 	All plug-in modules (see page 51)					
Expansion I/O supported	—	—	—				All expansion I/O modules (see page 41)	
Power supply	Embedded 120/240V AC and 12/24V DC options	Base unit has embedded 24V DC power supply, optional external 120/240V AC power supply available						
Basic instruction speed	2.5 μs per basic instruction	0.30 μs per basic instruction						
Minimum scan/cycle time ⁽³⁾	<0.25 ms	<4 ms	<0.25 ms					
Software	Connected Components Workbench							

(1) See [Number and Types of Inputs/Outputs for Micro810, Micro820, Micro830, and Micro850 Catalogs on page 6](#).

(2) For Micro820 and Micro830 controllers, the number of maximum digital I/O assumes 8-point digital I/O plug-ins (for example, 2080-IQ40B4) are used on all available plug-in slots. For Micro850 controllers, the maximum number of digital I/O supported between the base, plug-ins, and expansion I/O is 132.

(3) Including reading and writing I/O, program execution, and communications overhead.

Micro800 Controller Programming Comparison (with Connected Components Workbench)

Attribute	Micro810 12-point	Micro820 20-point	Micro830 10/16-point	Micro830 24-point	Micro830 48-point	Micro850 24-point	Micro850 48-point
Program steps ⁽¹⁾	2 K	10 K	4 K	10 K	10 K	10 K	10 K
Data bytes	2 KB	20 KB	8 KB	20 KB	20 KB	20 KB	20 KB
IEC 61131-3 languages	Ladder diagram, function block diagram, structured text						
User defined function blocks	Yes						
Floating point	32-bit and 64-bit						
PID Loop Control	Yes (number limited only by memory)						
Embedded serial port protocols	None	Modbus RTU Master/Slave, ASCII/Binary, CIP Serial					

(1) Estimated Program and Data size are “typical” – program steps and variables are created dynamically. 1 Program Step = 12 data bytes. The number of bytes per instruction can vary greatly from program to program and from programming language to programming language.

Micro800 Communication Options

Controller	USB programming port	Embedded Serial Port, Serial Port Plug-In			Embedded Ethernet	
		CIP Serial	Modbus RTU	ASCII/Binary	EtherNet/IP	Modbus TCP
Micro810	Yes (with adapter)	No				
Micro820	Yes (with 2080-REMLCD)	Yes	Master/Slave	Yes	Yes	Yes
Micro830	Yes	Yes	Master/Slave	Yes	No	No
Micro850	Yes	Yes	Master/Slave	Yes	Yes	Yes

Micro800 Controllers Analog I/O and TC/RTD Comparison

Attribute	Micro810	Micro820	Micro800 (with plug-ins)	Micro850 (with expansion I/O)
Performance level	LOW	LOW	MEDIUM	HIGH
Isolation to controller (increased noise immunity)	None	None	None	Yes
Resolution and Nominal Accuracy	Analog Input: 10-bit, 5% (2% with calibration)	Analog I/O: 12-bit, 5% (2% with calibration)	Analog I/O: 12-bit, 1% TC/RTD: ± 1 °C CJC for TC: ± 1.2 °C	Analog Input: 14-bit input, ± 0.1 % Analog Output: 12-bit output, 0.133%, current, 0.425% voltage TC: ± 0.5 ... ± 3.0 °C RTD: ± 0.2 ... ± 0.6 °C
Input update rate and filtering	Update rate only dependent on program scan, limited filtering	Update rate only dependent on program scan, limited filtering	200 ms/ch, 50/60 Hz filtering	8 ms all channels with or without 50/60 Hz filtering
Recommended maximum shielded cable length ⁽¹⁾	10 m			100 m

(1) These numbers are guidelines only. Maximum cable length is dependent on the application and other factors such as cable type, installation, required accuracy, sensor, and so on.

Micro800 Power Requirements⁽¹⁾

Controller/Module	Power Requirement
Micro810 12-point (with or without LCD)	3 W (5V A for AC module)
Micro820 20-point ⁽²⁾ (without plug-ins, max)	5.62 W
Micro830 and Micro850 (without plug-in/expansion I/O)	
10/16-point	5 W
24-point	8 W
48-point	11 W
Plug-in modules, each	1.44 W
Expansion I/O (system bus power consumption)	2085-IQ16 – 0.85 W 2085-IQ32T – 0.95 W 2085-IA8 – 0.75 W 2085-IM8 – 0.75 W 2085-OA8 – 0.90 W 2085-OB16 – 1.00 W 2085-OV16 – 1.00 W 2085-OW8 – 1.80 W 2085-OW16 – 3.20 W 2085-IF4 – 1.70 W 2085-IF8 – 1.75 W 2085-OF4 – 3.70 W 2085-IRT4 – 2.00 W

(1) When setting up a Micro800 system, verify that total power consumption of the controller, plug-in and expansion I/O does not exceed the output power capacity of the power supply used. See [External Power Supply \(2080-PS120-240VAC\) on page 59](#) for power supply specifications.

(2) Micro820 controllers require a maximum of 8.5 W with plug-ins.

Number and Types of Inputs/Outputs

Number and Types of Inputs/Outputs for Micro810, Micro820, Micro830, and Micro850 Catalogs

Controller Family	Catalogs	Inputs				Outputs			Analog Out 0...10V DC	Analog In 0...10V (shared with DC In)	PTO/PWM Support ⁽¹⁾	Embedded HSC Support ⁽²⁾
		120V AC	120 / 240V AC	24V DC/ V AC	12V DC	Relay	24V DC Source	24V DC Sink				
Micro810	2080-LC10-12QWB	–	–	8	–	4	–	–	–	4	–	–
	2080-LC10-12AWA	–	8	–	–	4	–	–	–	–	–	–
	2080-LC10-12QBB	–	–	8	–	–	4	–	–	4	–	–
	2080-LC10-12DWD	–	–	–	8	4	–	–	–	4	–	–
Micro820	2080-LC20-20QBB	–	–	12	–	–	7	–	1	4	1 (PWM)	–
	2080-LC20-20QWB	–	–	12	–	7	–	–	1	4	–	–
	2080-LC20-20AWB	8	–	4	–	7	–	–	1	4	–	–
	2080-LC20-20QBBR	–	–	12	–	–	7	–	1	4	1 (PWM)	–
	2080-LC20-20QWBR	–	–	12	–	7	–	–	1	4	–	–
	2080-LC20-20AWBR	8	–	4	–	7	–	–	1	4	–	–
Micro830	2080-LC30-10QWB	–	–	6	–	4	–	–	–	–	–	2
	2080-LC30-10QVB	–	–	6	–	–	–	4	–	–	1 (PTO/PWM)	2
	2080-LC30-16AWB	10	–	–	–	6	–	–	–	–	–	–
	2080-LC30-16QWB	–	–	10	–	6	–	–	–	–	–	2
	2080-LC30-16QVB	–	–	10	–	–	–	6	–	–	1 (PTO/PWM)	2
	2080-LC30-24QWB	–	–	14	–	10	–	–	–	–	–	4
	2080-LC30-24QVB	–	–	14	–	–	–	10	–	–	2 (PTO/PWM)	4
	2080-LC30-24QBB	–	–	14	–	–	10	–	–	–	2 (PTO/PWM)	4
	2080-LC30-48AWB	28	–	–	–	20	–	–	–	–	–	–
	2080-LC30-48QWB	–	–	28	–	20	–	–	–	–	–	6
	2080-LC30-48QVB	–	–	28	–	–	–	20	–	–	3 (PTO/PWM)	6
2080-LC30-48QBB	–	–	28	–	–	20	–	–	–	3 (PTO/PWM)	6	
Micro850	2080-LC50-24AWB	14	–	–	–	10	–	–	–	–	–	–
	2080-LC50-24QBB	–	–	14	–	–	10	–	–	–	2 (PTO/PWM)	4
	2080-LC50-24QVB	–	–	14	–	–	–	10	–	–	2 (PTO/PWM)	4
	2080-LC50-24QWB	–	–	14	–	10	–	–	–	–	–	4
	2080-LC50-48AWB	28	–	–	–	20	–	–	–	–	–	–
	2080-LC50-48QWB	–	–	28	–	20	–	–	–	–	–	6
	2080-LC50-48QBB	–	–	28	–	–	20	–	–	–	3 (PTO/PWM)	6
	2080-LC50-48QVB	–	–	28	–	–	–	20	–	–	3 (PTO/PWM)	6

(1) For Micro830 and Micro850, you need firmware revision 6.011 or later to use PWM output.

(2) Maximum number of embedded HSC supported.

Micro800 Catalog Number Details

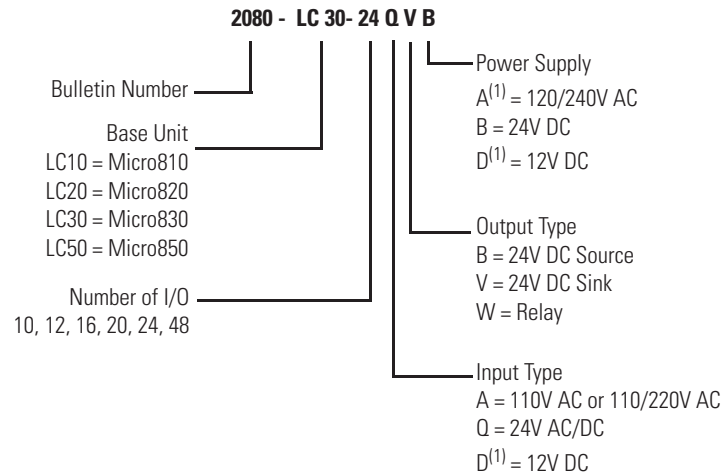

⁽¹⁾ Available for Micro810 only.

Connected Components Workbench Software

Connected Components Workbench™ is the programming and configuration software environment for the Micro800 controllers and our Connected Components products offering. It simplifies setup and usage, enabling applications ranging from simple Smart Relay up to Standalone Machine control.

Visit the website for the most up-to-date product information, downloads and tools:

<http://ab.rockwellautomation.com/Programmable-Controllers/Connected-Components-Workbench-Software>.

Standard Edition

Attribute	Basic
Delivery	Download Connected Components Workbench Standard Edition for FREE at http://ab.rockwellautomation.com/Programmable-Controllers/Connected-Components-Workbench-Software .
Packaging options	Available on DVD, orderable from Connected Components Workbench web page at http://ab.rockwellautomation.com/Programmable-Controllers/Connected-Components-Workbench-Software .
Features	<ul style="list-style-type: none"> • LD, FBD and ST editors • user-defined function blocks • No activation needed • Optional registration during installation (for product updates and notices)

Developer Edition

The Developer Edition offers the following additional programming features:

User-defined Structures

- You can combine different data types to create structures and then assign them to user-defined variables.
- Structures are useful when you want a single variable to hold several related pieces of information. For example, you might want to define a structure to keep temperature ranges and alarm levels for a device rather than creating multiple variables.

Spy Lists

You can define spy lists to monitor changes in variables and function block instances in Connected Components Workbench programs.

The Developer Edition installs the following additional software:

- FactoryTalk® Activation Manager v3.60.00 (CPR 9 SR 6)
- FactoryTalk Diagnostics v2.60.00 (CPR 9 SR 6)
- Microsoft Help Viewer 1.1

Note: The Developer Edition requires an activation key. See the FactoryTalk Activation help for additional information on activating Rockwell Automation software products.

Select a Micro810 Controller



As the smallest of the Micro800 family, the Micro810 controller is available in a 12-point version, with two 8 A and two 4 A outputs that eliminate the need for external relays. The Micro810 features embedded smart relay function blocks that can be configured from a 1.5" LCD and keypad. The function blocks include Delay OFF/ON Timer, Time of Day, Time of Week and Time of Year for applications requiring a programmable timer and lighting control. Programming can also be done through a program download via USB programming port, using Connected Components Workbench Software.

To help you select a Micro810 controller, consult the specifications for each catalog in the next section.

Number and Types of Inputs/Outputs

Catalog Number	Power	Inputs			Outputs		Analog In 0...10V (shared with DC In)	
		120V AC	240V AC	12...24V DC /V AC	Relay	24 V DC SRC		
2080-LC10-12QWB	24V DC			8	4		4	
2080-LC10-12AWA	120...240V AC	8			4			
2080-LC10-12QBB	12...24V DC			8		4	4	
2080-LC10-12DWD	12V DC			8	4		4	

Specifications⁽¹⁾

Attribute	2080-LC10-12AWA	2080-LC10-12QWB	2080-LC10-12DWD	2080-LC10-12QBB
Number of I/O	8 Input (4 digital, 4 analog/digital, configurable) 4 Output			
Dimensions HxWxD	91 x 75 x 59 mm (3.58 x 2.95 x 2.32 in.)			
Supply voltage range	85...263V DC	20.4...26.4V DC	10.8V...13.2V DC	11.4V...26.4V DC
Supply frequency range (AC supply)	47...63 Hz	–		
Voltage range	100...240V AC, 50/60 Hz	24V DC Class 2	12V DC Class 2	12/24V DC Class 2
Power consumption	5V A	3 W		
I/O rating	Input: 120...240V AC	Input: 24V DC, 8 mA	Input: 12V DC, 8 mA	Input: 24V DC, 8 mA
	Output: Relay 00 & 01: 8 A @ 240V AC, B300, R300, General Use Relay 02 & 03: 4 A @ 240V AC, C300, R150, General Use			Output: 24V DC 1A, 25 °C, 24V DC 0.5A 55 °C
Operating temperature	0...55 °C (32...131 °F)			
Shipping weight, approx.	0.203 kg (0.448 lb)			
Wire size	0.32...2.1 mm ² (22...14 AWG) solid copper wire or 0.32...1.3 mm ² (22...16 AWG) stranded copper wire rated @ 90 °C (194 °F) insulation max.			
Wiring category	2 – on signal ports 2 – on power ports			
Wiring torque	1.085 Nm (8 lb-in.)			
Wire type	use Copper Conductors only			
Fuse, type	Rated 250V 3.15 A-RADIAL			
Enclosure type rating	Meets IP20			
North American temp code	T5			
Insulation stripping length	7 mm (0.28 in.)			
Isolation voltage	250V (continuous), Reinforced Insulation Type, I/O to Aux and Network, Inputs to Outputs. Type tested for 60 s 3250V DC, I/O to Aux and Network, Inputs to Outputs	250V (continuous), Reinforced Insulation Type, I/O to Aux and Network, Inputs to Outputs Type tested for 60 s @ 720V DC, Inputs to Aux and Network, 3250V DC Outputs to Aux and Network, Inputs to Outputs	50V (continuous), Reinforced Insulation Type, I/O to Aux and Network, Inputs to Outputs Type tested for 60 s @ 720V DC, I/O to Aux and Network, Inputs to Outputs	
AC input filter setting	16 ms for all embedded inputs (In Connected Components Workbench, go to the Embedded I/O configuration window to re-configure the filter setting for each input group)			

(1) See the Micro810 User Manual, publication [2080-UM001](#), for more Micro810 controller specifications.

Environmental

Attribute	Value
Temperature, operating	IEC 60068-2-1 (Test Ad, Operating Cold), IEC 60068-2-2 (Test Bd, Operating Dry Heat), IEC 60068-2-14 (Test Nb, Operating Thermal Shock): 0...55 °C (32...131 °F)
Temperature, surrounding air, max	55 °C (131 °F)
Temperature, storage	IEC 60068-2-1 (Test Ab, Unpackaged Non-operating Cold), IEC 60068-2-2 (Test Bb, Unpackaged Non-operating Dry Heat), IEC 60068-2-14 (Test Na, Unpackaged Non-operating Thermal Shock): -40...85 °C (-40...185 °F)
Relative humidity	IEC 60068-2-30 (Test Db, Unpackaged Damp Heat): 5...95% non-condensing
Vibration	IEC 60068-2-6 (Test Fc, Operating): 2 g @ 10...500 Hz
Shock, operating	IEC 60068-2-27 (Test Ea, Unpackaged Shock): 30 g
Shock, nonoperating	IEC 60068-2-27 (Test Ea, Unpackaged Shock): 30 g (DIN Rail Mounted) 30 g (Panel Mounted)
Emissions	CISPR 11 Group 1, Class A
ESD immunity	IEC 61000-4-2: 4 kV contact discharges 8 kV air discharges
Radiated RF immunity	IEC 61000-4-3: 10V/m with 1 kHz sine-wave 80% AM from 80...2000 MHz 10V/m with 200 Hz 50% Pulse 100% AM @ 900 MHz 10V/m with 200 Hz 50% Pulse 100% AM @ 1890 MHz 3V/m with 1 kHz sine-wave 80% AM from 2000...2700 MHz
EFT/B immunity	IEC 61000-4-4: ±2 kV @ 5 kHz on power ports ±2 kV @ 5 kHz on signal ports
Surge transient immunity	IEC 61000-4-5: ±1 kV line-line(DM) and ±2 kV line-earth(CM) on power ports ±1 kV line-line(DM) and ±2 kV line-earth(CM) on signal ports ±2 kV line-earth(CM) on shielded ports
Conducted RF immunity	IEC 61000-4-6: 10V rms with 1 kHz sine-wave 80% AM from 150 kHz...80 MHz
Voltage variation	IEC 61000-4-11: 60% dip for 5 and 50 periods on AC supply ports 30% dip for 0.5 period at 0° and 180° on AC supply ports 100% dip for 0.5 period at 0° and 180° on AC supply ports ±10% fluctuations for 15 min on AC supply ports > 95% interruptions for 250 periods on AC supply ports

Certifications

Certification (when product is marked)⁽¹⁾	Value
c-UL-us	UL Listed Industrial Control Equipment, certified for US and Canada. See UL File E322657. UL Listed for Class I, Division 2 Group A,B,C,D Hazardous Locations, certified for U.S. and Canada. See UL File E334470.
CE	European Union 2004/108/EC EMC Directive, compliant with: EN 61000-6-2; Industrial Immunity EN 61000-6-4; Industrial Emissions EN 61131-2; Programmable Controllers (Clause 8, Zone A & B) EN 61131-2; Programmable Controllers (Clause 11)
C-Tick	Australian Radiocommunications Act, compliant with: AS/NZS CISPR 11; Industrial Emissions

(1) See the Product Certification link at <http://www.rockwellautomation.com/products/certification/> for Declaration of Conformity, Certificates, and other certification details.

For relay life chart, see the Specifications section of the Micro810 User Manual, publication [2080-UM001](#).

Select a Micro820 Controller



As one of the smaller controllers in the Micro800 family, the Micro820 controller comes as a 20-point form factor, with six catalogs available for selection. The Micro820 controller is designed for smaller standalone machines and remote automation projects.

It has the following features:

- Two plug-in module slots
- microSD card slot for project backup and restore, datalogging and recipe
- Embedded 10/100 Base-t Ethernet port(RJ-45)
- Support for Remote LCD module (2080-REMLCD) for configuration
- Embedded non-isolated RS232/RS485 combo serial port
- Modbus RTU protocol (serial port)
- Modbus TCP support
- EtherNet/IP support
- CIP Serial support

To help you select a Micro820 controller, consult the specifications for each catalog in the next section.

Number and Types of Inputs/Outputs for Micro820 Controllers

Controller Family	Catalogs	Inputs			Outputs			Analog Out 0...10V DC	Analog In 0...10V (shared with DC In)	PWM Support
		120V AC	120 /240V AC	24V DC	Relay	24V DC Source	24V DC Sink			
Micro820	2080-LC20-20QBB	–	–	12		7	–	1	4	1
	2080-LC20-20QWB	–	–	12	7	–	–	1	4	–
	2080-LC20-20AWB	8	–	4	7	–	–	1	4	–
	2080-LC20-20QBRR	–	–	12	–	7	–	1	4	1
	2080-LC20-20QWBR	–	–	12	7	–	–	1	4	–
	2080-LC20-20AWBR	8	–	4	7		–	1	4	–

Specifications

General Specifications

Attribute	2080-LC20-20AWB(R)	2080-LC20-20QBB(R)	2080-LC20-20QWB(R)																														
Number of I/O	12 inputs, 8 outputs																																
Dimension, HxWxD	90 x 104 x 75 mm (3.54 x 4.09 x 2.95 in.)																																
Shipping weight, approx.	0.38 kg (0.83 lb)																																
Wire size	<p>For fixed terminal blocks:</p> <table border="1"> <thead> <tr> <th></th> <th>Min</th> <th>Max</th> <th></th> </tr> </thead> <tbody> <tr> <td>Solid</td> <td>0.14 mm² (26 AWG)</td> <td>2.5 mm² (14 AWG)</td> <td rowspan="2">rated @ 90 °C (194 °F) insulation max</td> </tr> <tr> <td>Stranded</td> <td>0.14 mm² (26 AWG)</td> <td>1.5 mm² (16 AWG)</td> </tr> </tbody> </table> <p>For removable terminal blocks:</p> <table border="1"> <thead> <tr> <th></th> <th>Min</th> <th>Max</th> <th></th> </tr> </thead> <tbody> <tr> <td>Solid and Stranded</td> <td>0.2 mm² (24 AWG)</td> <td>2.5 mm² (14 AWG)</td> <td>rated @ 90 °C (194 °F) insulation max</td> </tr> </tbody> </table> <p>For RS232/RS485 serial port:</p> <table border="1"> <thead> <tr> <th></th> <th>Min</th> <th>Max</th> <th></th> </tr> </thead> <tbody> <tr> <td>Solid</td> <td>0.14 mm² (26 AWG)</td> <td>1.5 mm² (16 AWG)</td> <td rowspan="2">rated @ 90 °C (194 °F) insulation max</td> </tr> <tr> <td>Stranded</td> <td>0.14 mm² (26 AWG)</td> <td>1.0 mm² (18 AWG)</td> </tr> </tbody> </table>				Min	Max		Solid	0.14 mm ² (26 AWG)	2.5 mm ² (14 AWG)	rated @ 90 °C (194 °F) insulation max	Stranded	0.14 mm ² (26 AWG)	1.5 mm ² (16 AWG)		Min	Max		Solid and Stranded	0.2 mm ² (24 AWG)	2.5 mm ² (14 AWG)	rated @ 90 °C (194 °F) insulation max		Min	Max		Solid	0.14 mm ² (26 AWG)	1.5 mm ² (16 AWG)	rated @ 90 °C (194 °F) insulation max	Stranded	0.14 mm ² (26 AWG)	1.0 mm ² (18 AWG)
	Min	Max																															
Solid	0.14 mm ² (26 AWG)	2.5 mm ² (14 AWG)	rated @ 90 °C (194 °F) insulation max																														
Stranded	0.14 mm ² (26 AWG)	1.5 mm ² (16 AWG)																															
	Min	Max																															
Solid and Stranded	0.2 mm ² (24 AWG)	2.5 mm ² (14 AWG)	rated @ 90 °C (194 °F) insulation max																														
	Min	Max																															
Solid	0.14 mm ² (26 AWG)	1.5 mm ² (16 AWG)	rated @ 90 °C (194 °F) insulation max																														
Stranded	0.14 mm ² (26 AWG)	1.0 mm ² (18 AWG)																															
Wiring category ⁽¹⁾	2 – on signal ports 2 – on power ports 2 – on communication ports																																
Wire type	Use copper conductors or shielded cables																																

General Specifications

Attribute	2080-LC20-20AWB(R)	2080-LC20-20QBB(R)	2080-LC20-20QWB(R)
Terminal screw torque	For removable and fixed terminal blocks: 0.5...0.6 Nm (4.4...5.3 lb-in.) using a 0.6 x 3.5 mm flat-blade screwdriver. Note: Use a handheld screwdriver to hold down the screws at the side. For RS232/RS485 serial port: 0.22...0.25 Nm (1.95...2.21 lb-in.) using 0.4 x 2.5 x 80 mm 2-component grip with non-slip grip screwdriver.		
Input circuit type	24V DC sink/source (standard) – for 2080-LC20-20QWB(R), 2080-LC20-20QBB(R) 120V AC – for 2080-LC20-20AWB(R) for Inputs 4...11 only		
Output circuit type	Relay	24V DC source (standard and high-speed)	Relay
Power input	24V DC		
Power consumption	5.62 W (without plug-ins, max)...8.5 W (with plug-ins, max)		
Power dissipation	6 W		
Power supply voltage range	20.4...26.4 V DC, Class 2		
Auxiliary power supply output for thermistor	10V		
I/O rating	Input: 120V AC 16 mA Output: 2 A, 240 V AC 2A, 24V DC	Input: 24V DC, 8.8 mA Output: 24V DC, 1 A per point (Surrounding air temperature 30°C) 24 V DC, 0.3 A per point (Surrounding air temperature 65 °C)	Input: 24V DC, 8.8 mA Output: 2 A, 240 V AC, 2A, 24V DC
Isolation voltage	250V (continuous), Reinforced Insulation Type, Output to Aux and Network, Inputs to Outputs. 150V (continuous), Reinforced Insulation Type, Input to Aux and Network. Type tested for 60 s @ 3250 V DC Output to Aux and Network, Inputs to Outputs. Type tested for 60 s @ 1950 V DC Input to Aux and Network.	50V (continuous), Reinforced Insulation Type, I/O to Aux and Network, Inputs to Outputs. Type tested for 60 s @ 720 V DC, I/O to Aux and Network, Inputs to Outputs.	250V (continuous), Reinforced Insulation Type, Output to Aux and Network, Inputs to Outputs. 50V (continuous), Reinforced Insulation Type, Input to Aux and Network. Type tested for 60 s @ 720 V DC, Inputs to Aux and Network, 3250 V DC Outputs to Aux and Network, Inputs to Outputs.
Pilot duty rating	C300, R150	–	C300, R150
Insulation stripping length	<ul style="list-style-type: none"> • 7 mm for the removable and fixed terminal blocks • 5 mm for the RS232/RS485 serial port 		
Enclosure type rating	Meets IP20		
North American temp code	T4		

(1) Use this Conductor Category information for planning conductor routing. Refer to Industrial Automation Wiring and Grounding Guidelines, publication [1770-4.1](#).

Environmental Specifications

Attribute	Value
Temperature, operating	IEC 60068-2-1 (Test Ad, Operating Cold), IEC 60068-2-2 (Test Bd, Operating Dry Heat), IEC 60068-2-14 (Test Nb, Operating Thermal Shock): -20...65 °C (-4...149 °F)
Temperature, surrounding air, max	65 °C (149 °F)
Temperature, nonoperating	IEC 60068-2-1 (Test Ab, Unpackaged Nonoperating Cold), IEC 60068-2-2 (Test Bb, Unpackaged Nonoperating Dry Heat), IEC 60068-2-14 (Test Na, Unpackaged Nonoperating Thermal Shock): -40...85 °C (-40...185 °F)
Relative humidity	IEC 60068-2-30 (Test Db, Unpackaged Damp Heat): 5...95% non-condensing
Vibration	IEC 60068-2-6 (Test Fc, Operating): 2 g @ 10...500 Hz
Shock, operating	IEC 60068-2-27 (Test Ea, Unpackaged Shock): 25 g
Shock, non-operating	IEC 60068-2-27 (Test Ea, Unpackaged Shock): DIN mount: 25 g PANEL mount: 45 g
Emissions	CISPR 11 Group 1, Class A
ESD immunity	IEC 61000-4-2: 6 kV contact discharges 8 kV air discharges
Radiated RF immunity	IEC 61000-4-3: 10V/m with 1 kHz sine-wave 80% AM from 80...2000 MHz 10V/m with 200 Hz 50% Pulse 100% AM @ 900 MHz 10V/m with 200 Hz 50% Pulse 100% AM @ 1890 MHz 10V/m with 1 kHz sine-wave 80% AM from 2000...2700 MHz
EFT/B immunity	IEC 61000-4-4: ±2 kV @ 5 kHz on power ports ±2 kV @ 5 kHz on signal ports ±1 kV @ 5 kHz on communication ports
Surge transient immunity	IEC 61000-4-5: ±1 kV line-line(DM) and ±2 kV line-earth(CM) on power ports ±1 kV line-line(DM) and ±2 kV line-earth(CM) on signal ports ±1 kV line-earth(CM) on communication ports
Conducted RF immunity	IEC 61000-4-6: 10V rms with 1 kHz sine-wave 80% AM from 150 kHz...80 MHz

Certifications

Certification (when product is marked)⁽¹⁾	Value
c-UL-us	UL Listed Industrial Control Equipment, certified for US and Canada. See UL File E322657. UL Listed for Class I, Division 2 Group A,B,C,D Hazardous Locations, certified for U.S. and Canada. See UL File E334470.
CE	European Union 2004/108/EC EMC Directive, compliant with: EN 61326-1; Meas./Control/Lab., Industrial Requirements EN 61000-6-2; Industrial Immunity EN 61000-6-4; Industrial Emissions EN 61131-2; Programmable Controllers (Clause 8, Zone A & B) European Union 2006/95/EC LVD, compliant with: EN 61131-2; Programmable Controllers (Clause 11)
C-Tick	Australian Radiocommunications Act, compliant with: AS/NZS CISPR 11; Industrial Emissions
EtherNet/IP	ODVA conformance tested to EtherNet/IP specifications
KC	Korean Registration of Broadcasting and Communications Equipment, compliant with: Article 58-2 of Radio Waves Act, Clause 3

(1) See the Product Certification link at <http://www.rockwellautomation.com/products/certification> for Declaration of Conformity, Certificates, and other certification details.

For more information, see the Micro820 Programmable Controllers User Manual, publication [2080-UM005](#).

Notes:

Select a Micro830 Controller



The Micro830 controller allows integration of as many as five plug-in modules. The plug-in modules enable machine builders to personalize the controllers to increase functionality. Most models offer removable terminal blocks and simplified communication via serial port.

The controllers include:

- up to six embedded High-Speed Counter inputs (HSC)⁽¹⁾
- 100 kHz speed HSC available on 24V DC models
- up to three embedded Pulse Train Outputs (PTO) for basic positioning⁽²⁾
- High speed input interrupts
- Modbus RTU protocol (serial port)
- CIP Serial to allow tighter integration with PanelView Component
- Embedded USB programming and serial port (RS232/RS485)
- Plug-in slots to customize according to needs

To help you select a Micro830 controller, check out the specifications for each catalog in the next section.

(1) Embedded HSC is supported on all Micro830 catalog numbers, except on 2080-LC30-xxAWB.

(2) PTO is supported on Micro830 catalog numbers ending in BB or VB only.

Inputs and Outputs

Micro830 Controllers – Number and Type of Inputs/Outputs

Catalog Number	Inputs		Outputs			PTO/PWM Support	HSC Support ⁽¹⁾
	120V AC	24V DC/V AC	Relay	24V Sink	24V Source		
2080-LC30-10QWB		6	4				2
2080-LC30-10QVB		6		4		1	2
2080-LC30-16AWB	10		6				
2080-LC30-16QWB		10	6				2
2080-LC30-16QVB		10		6		1	2
2080-LC30-24QBB		14			10	2	4
2080-LC30-24QVB		14		10		2	4
2080-LC30-24QWB		14	10				4
2080-LC30-48AWB	28		20				
2080-LC30-48QBB		28			20	3	6
2080-LC30-48QVB		28		20		3	6
2080-LC30-48QWB		28	20				6

(1) Maximum number of HSC supported.

Micro830 Controllers General Features

Attribute	10-point 2080-LC30-10QWB 2080-LC30-10QVB	16-point 2080-LC30-16AWB 2080-LC30-16QWB 2080-LC30-16QVB	24-point 2080-LC30-24QWB 2080-LC30-24QVB 2080-LC30-24QBB	48-point 2080-LC30-48AWB 2080-LC30-48QWB 2080-LC30-48QVB 2080-LC30-48QBB
Number of I/O	10 (6 inputs, 4 outputs)	16 (10 inputs, 6 outputs)	24 (14 inputs, 10 outputs)	48 (28 inputs, 20 outputs)
Dimensions, HxWxD	90 x 100 x 80 mm (3.54 x 3.94 x 3.15 in.)	90 x 100 x 80 mm (3.54 x 3.94 x 3.15 in.)	90 x 150 x 80 mm (3.54 x 5.91 x 3.15 in.)	90 x 230 x 80 mm (3.54 x 9.06 x 3.15 in.)
Shipping weight, approx.	0.302 kg (0.666 lb)	0.302 kg (0.666 lb)	0.423 kg (0.933 lb)	0.725 kg (1.60 lb)
Operating temperature	-20...65 °C (-4...149 °F)			
Wire size	0.14...2.5 mm ² (26...14 AWG) solid copper wire or 0.14...1.5 mm ² (26...16 AWG) stranded copper wire rated @ 90 °C (194 °F) insulation max		0.2...2.5 mm ² (24...14 AWG) solid copper wire or 0.2...2.5 mm ² (24...14 AWG) stranded copper wire rated @ 90 °C (194 °F) insulation max	
Wiring category ⁽¹⁾	2 – on signal ports; 2 – on power ports			
Wire type	Use copper conductors only			
Terminal screw torque, max	0.6 Nm (4.4 lb-in.) (using a 2.5 mm (0.10 in.) flat-blade screwdriver)			
Power consumption	7.88 W		12.32 W	18.2 W
Power supply voltage range	20.4...26.4V DC Class 2			
Insulation stripping length	7 mm (0.28 in.)			
Enclosure type rating	Meets IP20			
North American temp code	T4			

(1) Use this Conductor Category information for planning conductor routing. Refer to Industrial Automation Wiring and Grounding Guidelines, publication [1770-4.1](#).

Micro830 Controllers 10- and 16-Point Controllers



General Specifications – 10-point controllers

Attribute	2080-LC30-10QWB	2080-LC30-10QVB
Input circuit type	12/24V sink/source (standard) 24V sink/source (high-speed)	
Output circuit type	Relay	24V DC sink transistor standard and high-speed
Event input interrupt support	Yes	
I/O rating	Input 24V DC, 8.8 mA Output 2 A, 240V AC, general use	Input 24V DC, 8.8 mA Output 2 A, 24V DC, 1 A per point (Surrounding air temperature 30 °C) 24V DC, 0.3 A per point (Surrounding air temperature 65 °C)
Isolation voltage	250V (continuous), Reinforced Insulation Type, Outputs to Aux and Network, Inputs to Outputs Type tested for 60 s @ 720V DC, Inputs to Aux and Network, 3250V DC Outputs to Aux and Network, Inputs to Outputs	50V (continuous), Reinforced Insulation Type, I/O to Aux and Network, Inputs to Outputs Type tested for 60 s @ 720V DC, I/O to Aux and Network, Inputs to Outputs
Pilot duty rating	C300, R150	—

General Specifications – 16-point controllers

Attribute	2080-LC30-16AWB	2080-LC30-16QWB	2080-LC30-16QVB
Input circuit type	120V AC	12/24V sink/source (standard) 24V sink/source (high-speed)	
Output circuit type	Relay	12/24V DC sink transistor standard and high-speed	
Event input interrupt support	Yes		

General Specifications – 16-point controllers

Attribute	2080-LC30-16AWB	2080-LC30-16QWB	2080-LC30-16QVB
I/O rating	Input 120V AC, 16 mA Output 2 A, 240V AC, general use	Input 24V DC, 8.8 mA Output 2 A, 240V AC, general use	Input 24V DC, 8.8 mA Output 24V DC, 1 A per point (Surrounding air temperature 30 °C) 24 V DC, 0.3 A per point (Surrounding air temperature 65 °C)
Isolation voltage	250V (continuous), Reinforced Insulation Type, Outputs to Aux and Network, Inputs to Outputs 2080-LC30-16AWB: Type tested for 60 s @ 3250V DC I/O to Aux and Network, Inputs to Outputs 2080-LC30-16QWB: Type tested for 60 s @ 720V DC, Inputs to Aux and Network, 3250V DC Outputs to Aux and Network, Inputs to Outputs		50V (continuous), Reinforced Insulation Type, I/O to Aux and Network, Inputs to Outputs Type tested for 60s @ 720V DC, I/O to Aux and Network, Inputs to Outputs
Pilot duty rating	C300, R150		—

Environmental Specifications

Attribute	Value
Temperature, operating	IEC 60068-2-1 (Test Ad, Operating Cold), IEC 60068-2-2 (Test Bd, Operating Dry Heat), IEC 60068-2-14 (Test Nb, Operating Thermal Shock): -20...65 °C (-4...149 °F)
Temperature, surrounding air, max	65 °C (149 °F)
Temperature, non-operating	IEC 60068-2-1 (Test Ab, Unpackaged Nonoperating Cold), IEC 60068-2-2 (Test Bb, Unpackaged Nonoperating Dry Heat), IEC 60068-2-14 (Test Na, Unpackaged Nonoperating Thermal Shock): -40...85 °C (-40...185 °F)
Relative humidity	IEC 60068-2-30 (Test Db, Unpackaged Damp Heat): 5...95% non-condensing
Vibration	IEC 60068-2-6 (Test Fc, Operating): 2 g @ 10...500 Hz
Shock, operating	IEC 60068-2-27 (Test Ea, Unpackaged Shock): 25 g
Shock, non-operating	IEC 60068-2-27 (Test Ea, Unpackaged Shock): DIN mount: 25 g PANEL mount: 45 g
Emissions	CISPR 11 Group 1, Class A
ESD immunity	IEC 61000-4-2: 6 kV contact discharges 8 kV air discharges
Radiated RF immunity	IEC 61000-4-3: 10V/m with 1 kHz sine-wave 80% AM from 80...2000 MHz 10V/m with 200 Hz 50% Pulse 100% AM @ 900 MHz 10V/m with 200 Hz 50% Pulse 100% AM @ 1890 MHz 10V/m with 1 kHz sine-wave 80% AM from 2000...2700 MHz
EFT/B immunity	IEC 61000-4-4: ±2 kV at 5 kHz on power ports ±2 kV at 5 kHz on signal ports
Surge transient immunity	IEC 61000-4-5: ±1 kV line-line(DM) and ±2 kV line-earth(CM) on power ports ±1 kV line-line(DM) and ±2 kV line-earth(CM) on signal ports

Environmental Specifications

Attribute	Value
Conducted RF immunity	IEC 61000-4-6; 10V rms with 1 kHz sine-wave 80% AM from 150 kHz...80 MHz

Certifications

Certification (when product is marked) ⁽¹⁾	Value
c-UL-us	UL Listed Industrial Control Equipment, certified for US and Canada. See UL File E322657. UL Listed for Class I, Division 2 Group A,B,C,D Hazardous Locations, certified for U.S. and Canada. See UL File E334470.
CE	European Union 2004/108/EC EMC Directive, compliant with: EN 61326-1; Meas./Control/Lab., Industrial Requirements EN 61000-6-2; Industrial Immunity EN 61000-6-4; Industrial Emissions EN 61131-2; Programmable Controllers (Clause 8, Zone A & B) European Union 2006/95/EC LVD, compliant with: EN 61131-2; Programmable Controllers (Clause 11)
C-Tick	Australian Radiocommunications Act, compliant with: AS/NZS CISPR 11; Industrial Emissions

(1) See the Product Certification link at <http://www.rockwellautomation.com/products/certification/> for Declaration of Conformity, Certificates, and other certification details.

Micro830 24-Point Controllers



General Specifications – 24-point controllers

Attribute	2080-LC30-24QWB	2080-LC30-24QVB	2080-LC30-24QBB
Input circuit type	24V DC sink/source standard and high-speed		
Output circuit type	Relay	24V DC sink standard and high-speed	24V DC source standard and high-speed
Event input interrupt support	Yes		
I/O rating	Input 24V DC, 8.8 mA Output 2 A, 240 V AC, general use	Input 24V DC, 8.8 mA Output 24V DC, Class 2, 1 A per point (Surrounding air temperature 30 °C) 24V DC, Class 2, 0.3 A per point (Surrounding air temperature 65 °C)	
Isolation voltage	250V (continuous), Reinforced Insulation Type, Outputs to Aux and Network, Inputs to Outputs Type tested for 60 s @ 720V DC, Inputs to Aux and Network, 3250V DC Outputs to Aux and Network, Inputs to Outputs	50V (continuous), Reinforced Insulation Type, I/O to Aux and Network, Inputs to Outputs Type tested for 60 s @ 720V DC, I/O to Aux and Network, Inputs to Outputs	
Pilot duty rating	C300, R150 (2080-LC30-24QWB only)	—	

Environmental Specifications

Attribute	Value
Temperature, operating	IEC 60068-2-1 (Test Ad, Operating Cold), IEC 60068-2-2 (Test Bd, Operating Dry Heat), IEC 60068-2-14 (Test Nb, Operating Thermal Shock): -20...65 °C (-4...149 °F)
Temperature, surrounding air, max	65 °C (149 °F)
Temperature, non-operating	IEC 60068-2-1 (Test Ab, Unpackaged Nonoperating Cold), IEC 60068-2-2 (Test Bb, Unpackaged Nonoperating Dry Heat), IEC 60068-2-14 (Test Na, Unpackaged Nonoperating Thermal Shock): -40...85 °C (-40...185 °F)
Relative humidity	IEC 60068-2-30 (Test Db, Unpackaged Damp Heat): 5...95% non-condensing

Environmental Specifications

Attribute	Value
Vibration	IEC 60068-2-6 (Test Fc, Operating): 2 g @ 10...500 Hz
Shock, operating	IEC 60068-2-27 (Test Ea, Unpackaged Shock): 25 g
Shock, non-operating	IEC 60068-2-27 (Test Ea, Unpackaged Shock): DIN mount: 25 g PANEL mount: 35 g
Emissions	CISPR 11 Group 1, Class A
ESD immunity	IEC 61000-4-2: 6 kV contact discharges 8 kV air discharges
Radiated RF immunity	IEC 61000-4-3: 10V/m with 1 kHz sine-wave 80% AM from 80...2000 MHz 10V/m with 200 Hz 50% Pulse 100% AM @ 900 MHz 10V/m with 200 Hz 50% Pulse 100% AM @ 1890 MHz 10V/m with 1 kHz sine-wave 80% AM from 2000...2700 MHz
EFT/B immunity	IEC 61000-4-4: ±2 kV at 5 kHz on power ports ±2 kV at 5 kHz on signal ports
Surge transient immunity	IEC 61000-4-5: ±1 kV line-line(DM) and ±2 kV line-earth(CM) on power ports ±1 kV line-line(DM) and ±2 kV line-earth(CM) on signal ports
Conducted RF immunity	IEC 61000-4-6: 10V rms with 1 kHz sine-wave 80% AM from 150 kHz...80 MHz

Certifications

Certification (when product is marked) ⁽¹⁾	Value
c-UL-us	UL Listed Industrial Control Equipment, certified for US and Canada. See UL File E322657. UL Listed for Class I, Division 2 Group A,B,C,D Hazardous Locations, certified for U.S. and Canada. See UL File E334470.
CE	European Union 2004/108/EC EMC Directive, compliant with: EN 61326-1; Meas./Control/Lab., Industrial Requirements EN 61000-6-2; Industrial Immunity EN 61000-6-4; Industrial Emissions EN 61131-2; Programmable Controllers (Clause 8, Zone A & B) European Union 2006/95/EC LVD, compliant with: EN 61131-2; Programmable Controllers (Clause 11)
C-Tick	Australian Radiocommunications Act, compliant with: AS/NZS CISPR 11; Industrial Emissions

(1) See the Product Certification link at <http://www.rockwellautomation.com/products/certification/> for Declaration of Conformity, Certificates, and other certification details.

Micro830 48-Point Controllers

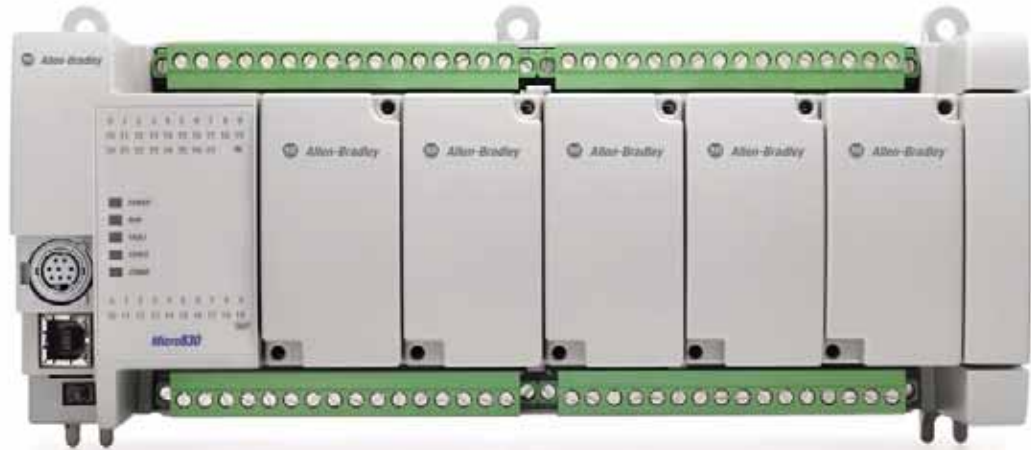

General Specifications – 48-point controllers

Attribute	2080-LC30-48AWB	2080-LC30-48QWB	2080-LC30-48QVB	2080-LC30-48QBB
Input circuit type	120V AC	24V DC sink/source standard and high-speed		
Output circuit type	Relay		24V DC sink standard and high-speed	24V DC source standard and high-speed
Event input interrupt support	Yes, inputs 0...15 only			
I/O rating	Input 120V AC, 16 mA Output 2 A, 240V AC, general use	Input 24V DC, 8.8 mA Output 2 A, 240V AC, general use	Input 24V DC, 8.8 mA Output 24V DC, 1 A per point (Surrounding air temperature 30 °C) 24 V DC, 0.3 A per point (Surrounding air temperature 65 °C)	
Pilot duty rating	C300, R150		–	
Isolation voltage	250V (continuous), Reinforced Insulation Type, Outputs to Aux and Network, Inputs to Outputs Type tested for 60 s @ 3250V DC I/O to Aux and Network, Inputs to Outputs	250V (continuous), Reinforced Insulation Type, Outputs to Aux and Network, Inputs to Outputs Type tested for 60 s @ 720V DC, Inputs to Aux and Network, 3250V DC Outputs to Aux and Network, Inputs to Outputs	50V (continuous), Reinforced Insulation Type, I/O to Aux and Network, Inputs to Outputs Type tested for 60 s @ 720V DC, I/O to Aux and Network, Inputs to Outputs	

Environmental Specifications

Attribute	Value
Temperature, operating	IEC 60068-2-1 (Test Ad, Operating Cold), IEC 60068-2-2 (Test Bd, Operating Dry Heat), IEC 60068-2-14 (Test Nb, Operating Thermal Shock): -20...65 °C (-4...149 °F)
Temperature, surrounding air, max	65 °C (149 °F)
Temperature, non-operating	IEC 60068-2-1 (Test Ab, Unpackaged Nonoperating Cold), IEC 60068-2-2 (Test Bb, Unpackaged Nonoperating Dry Heat), IEC 60068-2-14 (Test Na, Unpackaged Nonoperating Thermal Shock): -40...85 °C (-40...185 °F)
Relative humidity	IEC 60068-2-30 (Test Db, Unpackaged Damp Heat): 5...95% non-condensing
Vibration	IEC 60068-2-6 (Test Fc, Operating): 2 g @ 10...500 Hz
Shock, operating	IEC 60068-2-27 (Test Ea, Unpackaged Shock): 25 g
Shock, non-operating	IEC 60068-2-27 (Test Ea, Unpackaged Shock): DIN mount: 25 g PANEL mount: 35 g
Emissions	CISPR 11 Group 1, Class A
ESD immunity	IEC 61000-4-2: 6 kV contact discharges 8 kV air discharges
Radiated RF immunity	IEC 61000-4-3: 10V/m with 1 kHz sine-wave 80% AM from 80...2000 MHz 10V/m with 200 Hz 50% Pulse 100% AM @ 900 MHz 10V/m with 200 Hz 50% Pulse 100% AM @ 1890 MHz 10V/m with 1 kHz sine-wave 80% AM from 2000...2700 MHz
EFT/B immunity	IEC 61000-4-4: ±2 kV @ 5 kHz on power ports ±2 kV @ 5 kHz on signal ports
Surge transient immunity	IEC 61000-4-5: ±1 kV line-line(DM) and ±2 kV line-earth(CM) on power ports ±1 kV line-line(DM) and ±2 kV line-earth(CM) on signal ports
Conducted RF immunity	IEC 61000-4-6: 10V rms with 1 kHz sine-wave 80% AM from 150 kHz...80 MHz

Certifications

Certification (when product is marked)⁽¹⁾	Value
c-UL-us	UL Listed Industrial Control Equipment, certified for US and Canada. See UL File E322657. UL Listed for Class I, Division 2 Group A,B,C,D Hazardous Locations, certified for U.S. and Canada. See UL File E334470.
CE	European Union 2004/108/EC EMC Directive, compliant with: EN 61326-1; Meas./Control/Lab., Industrial Requirements EN 61000-6-2; Industrial Immunity EN 61000-6-4; Industrial Emissions EN 61131-2; Programmable Controllers (Clause 8, Zone A & B) European Union 2006/95/EC LVD, compliant with: EN 61131-2; Programmable Controllers (Clause 11)
C-Tick	Australian Radiocommunications Act, compliant with: AS/NZS CISPR 11; Industrial Emissions

(1) See the Product Certification link at <http://www.rockwellautomation.com/products/certification/> for Declaration of Conformity, Certificates, and other certification details.

For relay life chart, see the Specifications section of the Micro830 and Micro850 User Manual, publication [2080-UM002](#).

Embedded Serial Port Cables**Embedded Serial Port Cable Selection Chart**

Connectors	Length	Cat. No.		Connectors	Length	Cat. No.
8-pin Mini DIN to 8-pin Mini DIN	0.5 m (1.5 ft)	1761-CBL-AM00 ⁽¹⁾		8-pin Mini DIN to 9-pin D Shell	0.5 m (1.5 ft)	1761-CBL-AP00 ⁽¹⁾
8-pin Mini DIN to 8-pin Mini DIN	2 m (6.5 ft)	1761-CBL-HM02 ⁽¹⁾		8-pin Mini DIN to 9-pin D Shell	2 m (6.5 ft)	1761-CBL-PM02 ⁽¹⁾
				8-pin Mini DIN to 6-pin RS-485 terminal block	30 cm (11.8 in.)	1763-NC01 series A

(1) Series C or later for Class 1 Div 2 applications.

Select a Micro850 Controller



A Micro850 controller with a power supply, plug-in modules, and four expansion I/O modules attached

Micro850 controllers are suitable for applications that require more digital and analog I/O or higher performance analog I/O. These controllers can support up to four expansion I/O. It comes in a 24-point and 48-point form factor with an embedded Ethernet port.

Micro850 controllers include:

- Expansion I/O support
- up to six embedded High-Speed Counter inputs (HSC)⁽¹⁾
- 100 kHz speed HSC available on 24V DC models
- up to three embedded Pulse Train Outputs (PTO)⁽²⁾ for basic positioning
- High speed input interrupts
- Modbus RTU protocol (serial port)
- Modbus/TCP support
- EtherNet/IP support
- CIP Serial support
- Embedded USB programming and serial port (RS232/485)
- Embedded 10/100 Base-T Ethernet port (RJ45)
- Plug-in slots to customize according to needs

To help you select a Micro850 controller, see the following specifications.

(1) Embedded HSC is supported on all Micro850 catalog numbers, except on 2080-LC50-xxAWB.

(2) PTO is supported on Micro850 catalog numbers ending in BB or VB.

Micro850 Controllers – Number and Types of Inputs and Outputs

Catalog Number	Inputs		Outputs			PTO/ PWM Support	HSC Support ⁽¹⁾
	120V AC	24V DC/ V AC	Relay	24V Sink	24V Source		
2080-LC50-24AWB	14		10				
2080-LC50-24QBB		14			10	2	4
2080-LC50-24QVB		14		10		2	4
2080-LC50-24QWB		14	10				4
2080-LC50-48AWB	28		20				
2080-LC50-48QBB		28			20	3	6
2080-LC50-48QVB		28		20		3	6
2080-LC50-48QWB		28	20				6

(1) Maximum number of HSC supported.

Micro850 24-Point Controllers



General Specifications – 2080-LC50-24AWB, 2080-LC50-24QWB, 2080-LC50-24QVB, 2080-LC50-24QBB

Attribute	2080-LC50-24AWB	2080-LC50-24QWB	2080-LC50-24QVB	2080-LC50-24QBB
Number of I/O	24 (14 inputs, 10 outputs)			
Dimensions, HxWxD	90 x 158 x 80 mm (3.54 x 6.22 x 3.15 in.)			
Shipping weight, approx.	0.423 kg (0.933 lb)			

General Specifications – 2080-LC50-24AWB, 2080-LC50-24QWB, 2080-LC50-24QVB, 2080-LC50-24QBB

Attribute	2080-LC50-24AWB	2080-LC50-24QWB	2080-LC50-24QVB	2080-LC50-24QBB
Wire size		Min	Max	
	Solid	0.2 mm ² (24 AWG)	2.5 mm ² (14 AWG)	rated @ 90 °C (194 °F) insulation max
	Stranded	0.2 mm ² (24 AWG)	2.5 mm ² (14 AWG)	
Wiring category ⁽¹⁾	2 – on signal ports 2 – on power ports 2 – on communication ports			
Wire type	Use copper conductors only			
Terminal screw torque	0.6 Nm (4.4 lb-in.) max (using a 2.5 mm (0.10 in.) flat-blade screwdriver)			
Input circuit type	120V AC	24V DC sink/source standard and high-speed		
Output circuit type	Relay		24V DC sink standard and high-speed	24V DC source standard and high-speed
Power consumption	28 W			
Power supply voltage range	20.4...26.4V DC Class 2			
I/O rating	Input 120V AC 16 mA Output 2 A, 240 V AC, 24V DC	Input 24V, 8.8 mA Output 2 A, 240 V AC, 24V DC	Input 24V, 8.8 mA Output 24V DC, Class 2, 1 A per point (surrounding air temperature 30 °C) 24 V DC, Class 2, 0.3 A per point (surrounding air temperature 65 °C)	
Isolation voltage	250V (continuous), Reinforced Insulation Type, Output to Aux and Network, Inputs to Outputs. Type tested for 60 s @ 3250V DC Output to Aux and Network, Inputs to Outputs 150V (continuous), Reinforced Insulation Type, Input to Aux and Network. Type tested for 60 s @ 1950V DC Input to Aux and Network	250V (continuous), Reinforced Insulation Type, I/O to Aux and Network, Inputs to Outputs. Type tested for 60 s @ 3250V DC Output to Aux and Network, Inputs to Outputs. 50V (continuous), Reinforced Insulation Type, Input to Aux and Network Type tested for 60 s @ 720V DC, Inputs to Aux and Network.	50V (continuous), Reinforced Insulation Type, I/O to Aux and Network, Inputs to Outputs. Type tested for 60 s @ 720V DC, I/O to Aux and Network, Inputs to Outputs.	
Pilot duty rating	C300, R150		—	
Insulation stripping length	7 mm (0.28 in.)			
Enclosure type rating	Meets IP20			
North American temp code	T4			

(1) Use this Conductor Category information for planning conductor routing. Refer to Industrial Automation Wiring and Grounding Guidelines, publication [1770-4.1](#).

DC Input Specifications –2080-LC50-24QBB, 2080-LC50-24QVB, 2080-LC50-24QWB

Attribute	High-Speed DC Input (Inputs 0...7)	Standard DC Input (Inputs 8 and higher)
Number of Inputs	8	6
Voltage category	24V sink/source	
Input group to backplane isolation	Verified by one of the following dielectric tests: 720V DC for 2 s 50V DC working voltage (IEC Class 2 reinforced insulation)	
On-state voltage range	16.8...26.4V DC @ 65 °C (149 °F) 16.8...30.0V DC @ 30 °C (86 °F)	10...26.4V DC @ 65 °C (149°F) 10...30.0V DC @ 30 °C (86°F)
Off-state voltage, max	5V DC	
Off-state current, max	1.5 mA	
On-state current, min	5.0 mA @ 16.8V DC, min	1.8 mA @ 10V DC, min
On-state current, nom	7.6 mA @ 24V DC, nom	6.15 mA @ 24V DC, nom
On-state current, max	12.0 mA @ 30V DC, max	12.0 mA @ 30V DC, max
Nominal impedance	3 k Ω	3.74 k Ω
IEC input compatibility	Type 3	

AC Input Specifications – 2080-LC50-24AWB

Attribute	Value
Number of inputs	14
On-state voltage, min	79V AC, min
On-state voltage, max	132V AC, max
On-state current, min	5 mA
On-state current, max	16 mA
Input frequency, nom	50/60 Hz
Input frequency, min	47 Hz
Input frequency, max	63 Hz, max
Off-state voltage, max	20V AC @ 120V AC
Off-state current, max	2.5 mA @ 120V AC
Inrush current, max	250 mA @ 120V AC
Inrush delay time constant max	22 ms
IEC input compatibility	Type 3

Output Specifications

Attribute	2080-LC50-24QWB, 2080-LC50-24AWB	2080-LC50-24QVB, 2080-LC50-24QBB	
	Relay Output	Hi-Speed Output (Outputs 0...1)	Standard Output (Outputs 2 and higher)
Number of outputs	10	2	8
Output voltage, min	5V DC, 5V AC	10.8V DC	10V DC
Output voltage, max	125V DC, 265V AC	26.4V DC	26.4V DC
Load current, min	10 mA		
Load current, continuous, max	Refer to Relay Contacts Ratings on page 33	100 mA (high-speed operation) 1.0 A @ 30 °C 0.3 A @ 65 °C (standard operation)	1.0 A @ 30 °C 0.3 A @ 65 °C (standard operation)
Surge current, per point	Refer to Relay Contacts Ratings on page 33	4.0 A for 10 ms every 1 s @ 30 °C; every 2 s @ 65 °C ⁽¹⁾	
Current, per common, max	5 A	—	—
Turn on time/ Turn off time, max	10 ms	2.5 μs	0.1 ms 1 ms

(1) Applies for general purpose operation only; does not apply for high-speed operation.

Relay Contacts Ratings

Maximum Volts	Amperes		Amperes Continuous	Volt-Amperes	
	Make	Break		Make	Break
120V AC	15 A	1.5 A	2.0 A	1800V A	180V A
240V AC	7.5 A	0.75 A			
24V DC	1.0 A		1.0 A	28V A	
125V DC	0.22 A				

For relay life chart, see the Specifications section of the Micro830 and Micro850 User Manual, publication [2080-UM002](#).

Environmental Specifications

Attribute	Value
Temperature, operating	IEC 60068-2-1 (Test Ad, Operating Cold), IEC 60068-2-2 (Test Bd, Operating Dry Heat), IEC 60068-2-14 (Test Nb, Operating Thermal Shock): -20...65 °C (-4...149 °F)
Temperature, surrounding air, max	65 °C (149 °F)
Temperature, non-operating	IEC 60068-2-1 (Test Ab, Unpackaged Nonoperating Cold), IEC 60068-2-2 (Test Bb, Unpackaged Nonoperating Dry Heat), IEC 60068-2-14 (Test Na, Unpackaged Nonoperating Thermal Shock): -40...85 °C (-40...185 °F)
Relative humidity	IEC 60068-2-30 (Test Db, Unpackaged Damp Heat): 5...95% non-condensing
Vibration	IEC 60068-2-6 (Test Fc, Operating): 2 g @ 10...500 Hz
Shock, operating	IEC 60068-2-27 (Test Ea, Unpackaged Shock): 25 g
Shock, non-operating	IEC 60068-2-27 (Test Ea, Unpackaged Shock): DIN mount: 25 g PANEL mount: 35 g
Emissions	CISPR 11 Group 1, Class A
ESD immunity	IEC 61000-4-2: 6 kV contact discharges 8 kV air discharges
Radiated RF immunity	IEC 61000-4-3: 10V/m with 1 kHz sine-wave 80% AM from 80...2000 MHz 10V/m with 200 Hz 50% Pulse 100% AM @ 900 MHz 10V/m with 200 Hz 50% Pulse 100% AM @ 1890 MHz 10V/m with 1 kHz sine-wave 80% AM from 2000...2700 MHz
EFT/B immunity	IEC 61000-4-4: ±2 kV @ 5 kHz on power ports ±2 kV @ 5 kHz on signal ports ±1 kV @ 5 kHz on communication ports
Surge transient immunity	IEC 61000-4-5: ±1 kV line-line(DM) and ±2 kV line-earth(CM) on AC power ports ±1 kV line-line(DM) and ±2 kV line-earth(CM) on signal ports ±1 kV line-earth(CM) on communication ports
Conducted RF immunity	IEC 61000-4-6: 10V rms with 1 kHz sine-wave 80% AM from 150 kHz...80 MHz

Certifications

Certification (when product is marked) ⁽¹⁾	Value
c-UL-us	UL Listed Industrial Control Equipment, certified for US and Canada. See UL File E322657. UL Listed for Class I, Division 2 Group A,B,C,D Hazardous Locations, certified for U.S. and Canada. See UL File E334470.
CE	European Union 2004/108/EC EMC Directive, compliant with: EN 61326-1; Meas./Control/Lab., Industrial Requirements EN 61000-6-2; Industrial Immunity EN 61000-6-4; Industrial Emissions EN 61131-2; Programmable Controllers (Clause 8, Zone A & B) European Union 2006/95/EC LVD, compliant with: EN 61131-2; Programmable Controllers (Clause 11)
C-Tick	Australian Radiocommunications Act, compliant with: AS/NZS CISPR 11; Industrial Emissions
EtherNet/IP	ODVA conformance tested to EtherNet/IP specifications
KC	Korean Registration of Broadcasting and Communications Equipment, compliant with: Article 58-2 of Radio Waves Act, Clause 3

(1) See the Product Certification link at <http://www.rockwellautomation.com/products/certification> for Declaration of Conformity, Certificates, and other certification details.

Micro850 48-Point Controllers

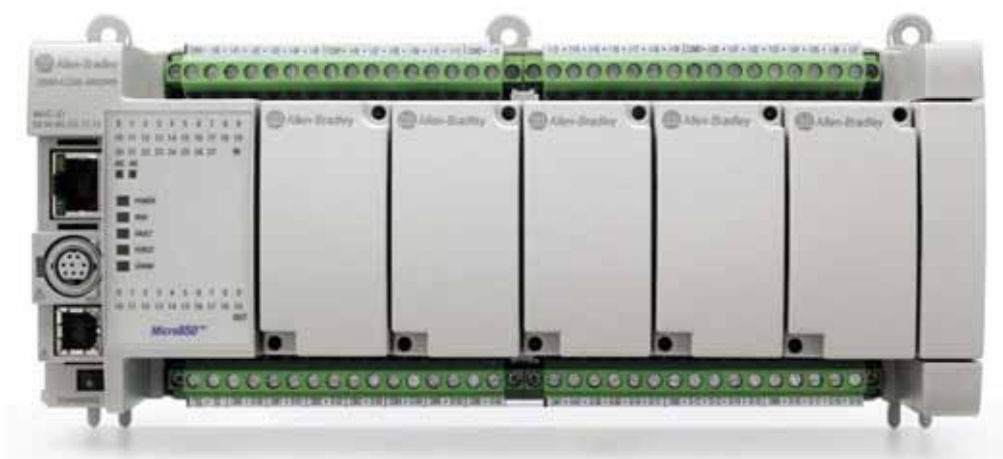

General Specifications – 2080-LC50-48AWB, 2080-LC50-48QWB, 2080-LC50-48QVB, 2080-LC50-48QBB

Attribute	2080-LC50-48AWB	2080-LC50-48QWB	2080-LC50-48QVB	2080-LC50-48QBB
Number of I/O	48 (28 inputs, 20 outputs)			
Dimensions, HxWxD	90 x 238 x 80 mm (3.54 x 9.37 x 3.15 in.)			
Shipping weight, approx.	0.725 kg (1.60 lb)			

General Specifications – 2080-LC50-48AWB, 2080-LC50-48QWB, 2080-LC50-48QVB, 2080-LC50-48QBB

Attribute	2080-LC50-48AWB	2080-LC50-48QWB	2080-LC50-48QVB	2080-LC50-48QBB									
Wire size	<table border="1"> <thead> <tr> <th></th> <th>Min</th> <th>Max</th> </tr> </thead> <tbody> <tr> <td>Solid</td> <td>0.2 mm² (24 AWG)</td> <td>2.5 mm² (14 AWG)</td> </tr> <tr> <td>Stranded</td> <td>0.2 mm² (24 AWG)</td> <td>2.5 mm² (14 AWG)</td> </tr> </tbody> </table>			Min	Max	Solid	0.2 mm ² (24 AWG)	2.5 mm ² (14 AWG)	Stranded	0.2 mm ² (24 AWG)	2.5 mm ² (14 AWG)	rated @ 90°C (194 °F), insulation max.	
	Min	Max											
Solid	0.2 mm ² (24 AWG)	2.5 mm ² (14 AWG)											
Stranded	0.2 mm ² (24 AWG)	2.5 mm ² (14 AWG)											
Wiring category ⁽¹⁾	2 – on signal ports 2 – on power ports 2 – on communication ports												
Wire type	Use copper conductors only												
Terminal screw torque	0.4...0.5 Nm (3.5...4.4 lb-in.) (using a 0.6 x 3.5 mm flat-blade screwdriver)												
Input circuit type	120V AC	24V DC sink/source standard and high-speed											
Output circuit type	Relay	24V DC sink standard and high-speed		24V DC source standard and high-speed									
Power consumption	33 W												
Power supply voltage range	20.4...26.4V DC Class 2												
I/O rating	Input 120V AC, 16 mA Output 2 A, 240V AC, 2 A, 24V DC	Input 24V DC, 8.8 mA Output 2 A, 240V AC, 2 A, 24V DC	Input 24V DC, 8.8 mA Output 24V DC, 1 A per point (Surrounding air temperature 30 °C) 24V DC, 0.3 A per point (Surrounding air temperature 65 °C)										
Insulation stripping length	7 mm (0.28 in.)												
Enclosure type rating	Meets IP20												
Pilot duty rating	C300, R150		—										
Isolation voltage	250V (continuous), Reinforced Insulation Type, Output to Aux and Network, Inputs to Outputs Type tested for 60 s @ 3250V DC Output to Aux and Network, Inputs to Outputs. 150V (continuous), Reinforced Insulation Type, Input to Aux and Network Type tested for 60 s @ 1950V DC Input to Aux and Network	250V (continuous), Reinforced Insulation Type, I/O to Aux and Network, Inputs to Outputs Type tested for 60 s @ 3250V DC Output to Aux and Network, Inputs to Outputs. 50V (continuous), Reinforced Insulation Type, Input to Aux and Network Type tested for 60 s @ 720V DC, Inputs to Aux and Network	50V (continuous), Reinforced Insulation Type, I/O to Aux and Network, Inputs to Outputs Type tested for 60 s @ 720V DC, I/O to Aux and Network, Inputs to Outputs.										
North American temp code	T4												

(1) Use this Conductor Category information for planning conductor routing. Refer to Industrial Automation Wiring and Grounding Guidelines, publication [1770-4.1](#).

Input Specifications

Attribute	2080-LC50-48AWB	2080-LC50-48QWB / 2080-LC50-48QVB / 2080-LC50-48QBB	
	120V AC Input	High-Speed DC Input (Inputs 0...11)	Standard DC Input (Inputs 12 and higher)
Number of Inputs	28	12	16
Input group to backplane isolation	Verified by the following dielectric tests: 1950V AC for 2 s 150V working voltage (IEC Class 2 reinforced insulation)	Verified by the following dielectric tests: 720V DC for 2 s 50V DC working voltage (IEC Class 2 reinforced insulation)	
Voltage category	110V AC	24V DC sink/source	
Operating voltage range	132V, 60Hz AC max	16.8...26.4V DC @ 65 °C (149 °F) 16.8...30.0V DC @ 30 °C (86 °F)	10...26.4V DC @ 65 °C (149 °F) 10...30.0V DC @ 30 °C (86 °F)

Input Specifications

Attribute	2080-LC50-48AWB	2080-LC50-48QWB / 2080-LC50-48QVB / 2080-LC50-48QBB	
	120V AC Input	High-Speed DC Input (Inputs 0...11)	Standard DC Input (Inputs 12 and higher)
Off-state voltage, max	20V AC	5V DC	
Off-state current, max	1.5 mA	1.5 mA	
On-state current, min	5 mA @ 79V AC	5.0 mA @ 16.8V DC	1.8 mA @ 10V DC
On-state current, nom	12 mA @ 120V AC	7.6 mA @ 24V DC	6.15 mA @ 24V DC
On-state current, max	16 mA @ 132V AC	12.0 mA @ 30V DC	
Nominal impedance	12 k Ω @ 50 Hz 10 k Ω @ 60 Hz	3 k Ω	3.74 k Ω
IEC input compatibility	Type 3		
Inrush current, max	250 mA @ 120V AC	—	
Input frequency, max	63 Hz	—	

Output Specifications

Attribute	2080-LC50-48AWB / 2080-LC50-48QWB	2080-LC50-48QVB / 2080-LC50-48QBB	
	Relay Output	Hi-Speed Output (Outputs 0 through 3)	Standard Output (Outputs 4 and higher)
Number of outputs	20	4	16
Output voltage, min	5V DC, 5V AC	10.8V DC	10V DC
Output voltage, max	125V DC, 265V AC	26.4V DC	26.4V DC
Load current, min	10 mA		
Load current, max	2.0 A	100 mA (high-speed operation) 1.0 A @ 30 °C 0.3 A @ 65 °C (standard operation)	1.0 A @ 30 °C 0.3 A @ 65 °C (standard operation)
Surge current, per point	See Relay Contacts Ratings on page 33	4.0 A for 10 ms every 1 s @ 30 °C; every 2 s @ 65 °C ⁽¹⁾	
Current, per common, max	5 A	—	—
Turn on time/ Turn off time, max	10 ms	2.5 μ s	0.1 ms 1 ms

(1) Applies for general purpose operation only. Does not apply for high-speed operation.

Relay Contacts Ratings

Maximum Volts	Amperes		Amperes Continuous	Volt-Amperes	
	Make	Break		Make	Break
120V AC	15 A	1.5 A	2.0 A	1800V A	180V A
240V AC	7.5 A	0.75 A			
24V DC	1.0 A		1.0 A	28V A	
125V DC	0.22 A				

For relay life chart, see the Specifications section of the Micro830 and Micro850 User Manual, publication [2080-UM002](#).

Environmental Specifications

Attribute	Value
Temperature, operating	IEC 60068-2-1 (Test Ad, Operating Cold), IEC 60068-2-2 (Test Bd, Operating Dry Heat), IEC 60068-2-14 (Test Nb, Operating Thermal Shock): -20...65 °C (-4...149 °F)
Temperature, surrounding air, max	65 °C (149 °F)
Temperature, non-operating	IEC 60068-2-1 (Test Ab, Unpackaged Nonoperating Cold), IEC 60068-2-2 (Test Bb, Unpackaged Nonoperating Dry Heat), IEC 60068-2-14 (Test Na, Unpackaged Nonoperating Thermal Shock): -40...85 °C (-40...185 °F)
Relative humidity	IEC 60068-2-30 (Test Db, Unpackaged Damp Heat): 5...95% non-condensing
Vibration	IEC 60068-2-6 (Test Fc, Operating): 2 g @ 10...500 Hz
Shock, operating	IEC 60068-2-27 (Test Ea, Unpackaged Shock): 25 g
Shock, non-operating	IEC 60068-2-27 (Test Ea, Unpackaged Shock): DIN mount: 25 g PANEL mount: 35 g
Emissions	CISPR 11 Group 1, Class A
ESD immunity	IEC 61000-4-2: 4 kV contact discharges 8 kV air discharges
Radiated RF immunity	IEC 61000-4-3: 10V/m with 1 kHz sine-wave 80% AM from 80...2000 MHz 10V/m with 200 Hz 50% Pulse 100% AM @ 900 MHz 10V/m with 200 Hz 50% Pulse 100% AM @ 1890 MHz 10V/m with 1 kHz sine-wave 80% AM from 2000...2700 MHz
EFT/B immunity	IEC 61000-4-4: ±2 kV @ 5 kHz on power ports ±2 kV @ 5 kHz on signal ports ±1 kV @ 5 kHz on communication ports
Surge transient immunity	IEC 61000-4-5: ±1 kV line-line(DM) and ±2 kV line-earth(CM) on power ports ±1 kV line-line(DM) and ±2 kV line-earth(CM) on signal ports ±1 kV line-earth(CM) on communication ports
Conducted RF immunity	IEC 61000-4-6: 10V rms with 1 kHz sine-wave 80% AM from 150 kHz...80 MHz

Certifications

Certification (when product is marked)⁽¹⁾	Value
c-UL-us	UL Listed Industrial Control Equipment, certified for US and Canada. See UL File E322657. UL Listed for Class I, Division 2 Group A,B,C,D Hazardous Locations, certified for U.S. and Canada. See UL File E334470.
CE	European Union 2004/108/EC EMC Directive, compliant with: EN 61326-1; Meas./Control/Lab., Industrial Requirements EN 61000-6-2; Industrial Immunity EN 61000-6-4; Industrial Emissions EN 61131-2; Programmable Controllers (Clause 8, Zone A & B) European Union 2006/95/EC LVD, compliant with: EN 61131-2; Programmable Controllers (Clause 11)
C-Tick	Australian Radiocommunications Act, compliant with: AS/NZS CISPR 11; Industrial Emissions
EtherNet/IP	ODVA conformance tested to EtherNet/IP specifications.
KC	Korean Registration of Broadcasting and Communications Equipment, compliant with: Article 58-2 of Radio Waves Act, Clause 3.

(1) See the Product Certification link at <http://www.rockwellautomation.com/products/certification> for Declaration of Conformity, Certificates, and other certification details.

Notes:

Select Micro850 Expansion I/O

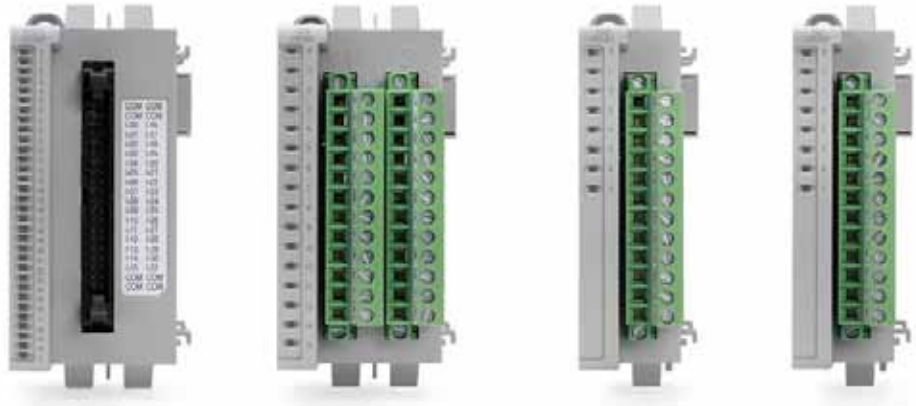

The 2085 I/O expansion modules provide superior functionality in a small-sized low-cost package. A variety of digital and analog modules complement and extend the capabilities of Micro850 controllers by maximizing the flexibility of I/O count and type.

Micro850 expansion I/O modules include high density discrete and analog I/O modules, including a high accuracy RTD and Thermocouple module.

There are available solid state output modules which are recommended to reduce switching noise and for applications which require more switching cycles, than relays. Triac outputs are available for AC loads. Sink and source transistor outputs are available for DC loads.

The following section provides the list of available Micro850 expansion I/O modules and their specifications.

Micro850 Expansion I/O Modules

Catalog Number	Type	Description
2085-IA8	Discrete	8-point, 120V AC input
2085-IM8	Discrete	8-point, 240V AC input
2085-OA8	Discrete	8-point, 120/240V AC Triac Output
2085-IQ16	Discrete	16-point, 12/24V DC Sink/Source Input
2085-IQ32T	Discrete	32-point, 12/24V DC Sink/Source Input
2085-OV16	Discrete	16-point, 12/24V DC Sink Transistor Output
2085-OB16	Discrete	16-point, 12/24V DC Source Transistor Output
2085-OW8	Discrete	8-point, AC/DC Relay Output
2085-OW16	Discrete	16-point, AC/DC Relay Output

Micro850 Expansion I/O Modules

Catalog Number	Type	Description
2085-IF4	Analog	4-channel, 14-bit isolated ⁽²⁾ voltage/current input
2085-IF8	Analog	8-channel, 14-bit isolated ⁽²⁾ voltage/current input
2085-OF4	Analog	4-channel, 12-bit isolated ⁽²⁾ voltage/current output
2085-IRT4	Specialty	4-channel, 16-bit RTD and TC isolated ⁽²⁾ input module
2085-ECR ⁽¹⁾	Terminator	2085 bus terminator

(1) The 2085-ECR bus terminator should always be the last module on the system, if any expansion I/O module is attached to the system.

(2) Refers to isolation from field side wiring to controller, **not** channel-to-channel isolation.

Discrete Expansion I/O**2085-IQ16 and 2085-IQ32T DC Sink/Source Input Modules⁽¹⁾**

Attribute	2085-IQ16	2085-IQ32T
Number of inputs	16 sink/source	32 sink/source
Dimensions, HxWxD	44.5 x 90 x 87 mm (1.75 x 3.54 x 3.42 in.)	
Shipping weight, approx.	220 g (7.76 oz)	
Bus current draw, max	170 mA @ 5V DC	190 mA @ 5V DC
Wire size	0.25... 2.5 mm ² (22...14 AWG) solid or stranded copper wire rated @ 75 °C (167 °F), or greater, 1.2 mm (3/64 in.) insulation max	
Wiring category ⁽²⁾	2 – on signal ports	
Terminal screw torque, max	0.5...0.6 Nm (4.4...5.3 lb-in.) ⁽³⁾	
Input circuit type	24V AC/DC sink/source	
Power dissipation, total	4.5 W	7 W
Power supply	24V DC	
Status indicators	16 yellow indicators	32 yellow indicators
Isolation voltage	50V (continuous), Reinforced Insulation Type, channel to system Type tested @ 720V DC for 60 s	
Enclosure type rating	Meets IP20	
North American temp code	T4	
Operating voltage range	10...30V DC, Class 2 21.6...26.4V AC, Class 2 See Derating Curve for 2085-IQ16 and Derating Curve for 2085-IQ32T on page 43	
Off-state voltage, max	5V DC	

2085-IQ16 and 2085-IQ32T DC Sink/Source Input Modules⁽¹⁾

Attribute	2085-IQ16	2085-IQ32T
Off-state current, max	1.5 mA	1.2 mA
On-state current, min	1.8 mA @ 10V DC	
On-state current, nom	6.0 mA @ 24V DC	5.2 mA @ 24V DC
On-state current, max	8.0 mA @ 30V DC	7.0 mA @ 30V DC
Input impedance, max	3.9 k Ω	4.6 k Ω
IEC input compatibility	Type 3	Type 1

- (1) Meets IEC Type 1 24V DC Input Specifications.
- (2) Use this Conductor Category information for planning conductor routing. Refer to Industrial Automation Wiring and Grounding Guidelines, publication [1770-4.1](#).
- (3) RTB hold down screws should be tightened by hand. They should not be tightened using a power tool.

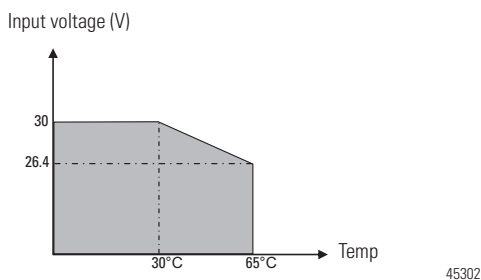
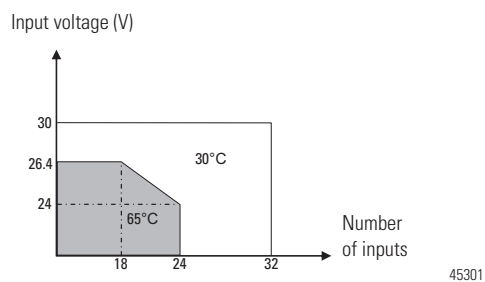
Derating Curve for 2085-IQ16

Derating Curve for 2085-IQ32T

2085-OV16 Sink and 2085-OB16 Source DC Output Module

Attribute	2085-OV16	2085-OB16
Number of outputs	16 sinking	16 sourcing
Operating voltage range	10...30V DC	
On-state voltage, min	10V DC	
On-state voltage, nom	24V DC	
On-state voltage, max	30V DC	
On-state current, max	0.5 A @ 30V DC, per output 8 A, per module	
Dimensions, HxWxD	44.5 x 90 x 87 mm (1.75 x 3.54 x 3.42 in.)	

2085-OV16 Sink and 2085-OB16 Source DC Output Module

Attribute	2085-OV16	2085-OB16
Shipping weight, approx.	220 g (7.76 oz)	
Bus current draw, max	200 mA @ 5V DC	
Wire size	0.25... 2.5 mm ² (22...14 AWG) solid or stranded copper wire rated @ 75 °C (167 °F), or greater, 1.2 mm (3/64 in.) insulation max	
Wiring category ⁽¹⁾	2 – on signal ports	
Terminal screw torque, max	0.5...0.6 Nm (4.4...5.3 lb-in.) ⁽²⁾	
Output circuit type	24V DC sink	24V DC source
Power dissipation, total	5 W	
Power supply	24V DC, Class 2	
Status indicators	16 Yellow channel indicators	
Isolation voltage	50V (continuous), Reinforced Insulation Type, channel to system Type tested @ 720V AC for 60 s	
Enclosure type rating	Meets IP20	
North American temp code	T4	

(1) Use this Conductor Category information for planning conductor routing. Refer to Industrial Automation Wiring and Grounding Guidelines, publication [1770-4.1](#).

(2) RTB hold down screws should be tightened by hand. They should not be tightened using a power tool.

2085-IA8, 2085-IM8, 2085-OA8 AC Input/Output Modules

Attribute	2085-IA8	2085-IM8	2085-OA8
Number of inputs	8		
Dimensions, HxWxD	28 x 90 x 87 mm (1.10 x 3.54 x 3.42 in.)		
Shipping weight, approx.	140 g (4.93 oz)		
Bus current draw, max	5V DC, 150 mA	5V DC, 180 mA	
Wire size	0.25... 2.5 mm ² (22...14 AWG) solid or stranded copper wire rated @ 75 °C (167 °F), or greater, 1.2 mm (3/64 in.) insulation max		
Insulation stripping length	10 mm (0.39 in.)		
Wiring category ⁽¹⁾	2 – on signal ports		
Wire type	Copper		
Terminal screw torque, max	0.5...0.6 Nm (4.4...5.3 lb-in.) ⁽²⁾		
Input/output circuit type	120V AC input	240V AC input	120V/240V AC output
Power supply	120V AC	240V AC	120V/240V AC
Power dissipation, total	2.36 W	2.34 W	5.19 W
Enclosure type rating	Meets IP20		

2085-IA8, 2085-IM8, 2085-OA8 AC Input/Output Modules

Attribute	2085-IA8	2085-IM8	2085-OA8
Status indicators	8 yellow indicators		
Isolation voltage	150V (continuous), Reinforced Insulation Type, channel to system Type tested @ 1950V DC for 60 s	240V (continuous), Reinforced Insulation Type, channel to system Type tested @ 3250V DC for 60 s	
North American temp code	T4		

(1) Use this Conductor Category information for planning conductor routing. Refer to Industrial Automation Wiring and Grounding Guidelines, publication [1770-4.1](#).

(2) RTB hold down screws should be tightened by hand. They should not be tightened using a power tool.

Input Specifications – 2085-IA8 and 2085-IM8

Attribute	2085-IA8	2085-IM8
Number of Inputs	8	
Voltage category	120V AC	240V AC
Operating voltage range	74...120V AC	159...240V AC
Off-state voltage, max	20V AC	40V AC
Off-state current, max	2.5 mA	
On-state current, min	5.0 mA @ 74V AC	4.0 mA @ 159V AC
On-state current, max	12.5 mA @ 120V AC	7.0 mA @ 240V AC
Input impedance, max	22.2 kΩ	
Inrush current, max	450 mA	
Input filter time Off to On On to Off	≤ 20 ms	
IEC type compliance	Type 3	

Output Specifications – 2085-OA8

Attribute	2085-OA8
Number of Inputs	8
Voltage category	120V/230V AC
Operating voltage range	120...240V AC
Output voltage, min	85V AC
Output voltage, max	240V AC
Off-state current, max	2.5 mA
On-state current, min	10 mA per output
On-state current, max	0.5 A per output
On-state current, per module, max	4 A
Off-state voltage drop, max	1.5V AC @ 0.5 A 2.5V AC @ 10 mA
Fusing	Not protected. A suitable rating fuse is recommended to protect outputs.

Output Specifications – 2085-OA8

Attribute	2085-OA8
Output signal delay Off to On On to Off	9.3 ms for 60 Hz, 11 ms for 50 Hz 9.3 ms for 60 Hz, 11 ms for 50 Hz
Surge current, max	5 A

2085-OW8 and 2085-OW16 Relay Output Module

Attribute	2085-OW8	2085-OW16																													
Number of outputs	8, relay	16, relay																													
Dimensions, HxWxD	28 x 90 x 87 mm (1.10 x 3.54 x 3.42 in.)	44.5 x 90 x 87 mm (1.75 x 3.54 x 3.42 in.)																													
Shipping weight, approx.	140 g (4.93 oz)	220 g (7.76 oz)																													
Wire size	0.25... 2.5 mm ² (22...14 AWG) solid or stranded copper wire rated @ 75 °C (167 °F), or greater, 1.2 mm (3/64 in.) insulation max																														
Insulation strip length	10 mm (0.39 in.)																														
Wiring category ⁽¹⁾	2 – on signal ports																														
Wire type	Copper																														
Terminal screw torque, max	0.5...0.6 Nm (4.4...5.3 lb-in.) ⁽²⁾																														
Bus current draw, max	5V DC, 120 mA 24V DC, 50 mA	5V DC, 160 mA 24V DC, 100 mA																													
Load current, max	2 A																														
Power dissipation, total	2.72 W	5.14 W																													
Relay contact, (0.35 power factor)	<table border="1"> <thead> <tr> <th rowspan="2">Max Volts</th> <th colspan="2">Amperes</th> <th>Amperes</th> <th colspan="2">Volt Amperes</th> </tr> <tr> <th>Make</th> <th>Break</th> <th>Continuous</th> <th>Make</th> <th>Break</th> </tr> </thead> <tbody> <tr> <td>120V AC</td> <td>15 A</td> <td>1.5 A</td> <td rowspan="2">2.0 A</td> <td rowspan="2">1800V A</td> <td rowspan="2">180V A</td> </tr> <tr> <td>240V AC</td> <td>7.5 A</td> <td>0.75 A</td> </tr> <tr> <td>24V DC</td> <td colspan="2">1.0 A</td> <td rowspan="2">1.0 A</td> <td colspan="2" rowspan="2">28V A</td> </tr> <tr> <td>125V DC</td> <td colspan="2">0.22 A</td> </tr> </tbody> </table>		Max Volts	Amperes		Amperes	Volt Amperes		Make	Break	Continuous	Make	Break	120V AC	15 A	1.5 A	2.0 A	1800V A	180V A	240V AC	7.5 A	0.75 A	24V DC	1.0 A		1.0 A	28V A		125V DC	0.22 A	
Max Volts	Amperes			Amperes	Volt Amperes																										
	Make	Break	Continuous	Make	Break																										
120V AC	15 A	1.5 A	2.0 A	1800V A	180V A																										
240V AC	7.5 A	0.75 A																													
24V DC	1.0 A		1.0 A	28V A																											
125V DC	0.22 A																														
Minimum load, per point	10 mA per point																														
Off-state leakage, max	1.5 mA																														
Status indicators	8 yellow indicators	16 yellow indicators																													
Isolation voltage	240V (continuous), Reinforced Insulation Type, channel to system Type tested @ 3250V DC for 60 s																														
Pilot duty rating	C300, R150																														
Enclosure type rating	Meets IP20																														
North American temp code	T4																														

(1) Use this Conductor Category information for planning conductor routing. Refer to Industrial Automation Wiring and Grounding Guidelines, publication [1770-4.1](#).

(2) RTB hold down screws should be tightened by hand. They should not be tightened using a power tool.

Analog Expansion I/O

2085-IF4, 2085-IF8, 2085-OF4 Analog Input and Output Modules

Attribute	2085-IF4	2085-OF4	2085-IF8
Number of I/O	4		8
Dimensions, HxWxD	28 x 90 x 87 mm (1.1 x 3.54 x 3.42 in.)		44.5 x 90 x 87 mm (1.75 x 3.54 x 3.42 in.)
Shipping weight, approx.	140 g (4.93 oz)		220 g (7.76 oz)
Bus current draw, max	5V DC, 100 mA 24V DC, 50 mA	5V DC, 160 mA 24V DC, 120 mA	5V DC, 110 mA 24V DC, 50 mA
Wire size	0.25... 2.5 mm ² (22...14 AWG) solid or stranded copper wire rated @ 75 °C (167 °F), or greater, 1.2 mm (3/64 in.) insulation max		
Wiring category ⁽¹⁾	2 – on signal ports		
Wire type	Shielded		
Terminal screw torque	0.5...0.6 Nm (4.4...5.3 lb-in.) ⁽²⁾		
Power dissipation, total	1.7 W	3.7 W	1.75 W
Enclosure type rating	Meets IP20		
Status indicators	1 green health indicator	1 green health indicator	1 green health indicator 8 red error indicators
Isolation voltage	50V (continuous), Reinforced Insulation Type, channel to system and channel to channel. Type tested @ 720V DC for 60 s		
North American temp code	T4		

(1) Use this Conductor Category information for planning conductor routing. Refer to Industrial Automation Wiring and Grounding Guidelines, publication [1770-4.1](#).

(2) RTB hold down screws should be tightened by hand. They should not be tightened using a power tool.

Input Specifications – 2085-IF4 and 2085-IF8

Attribute	2085-IF4	2085-IF8
Number of inputs	4	8
Resolution	14 bits (13 bits plus sign bit)	
Voltage	1.28 mV/cnt unipolar; 1.28 mV/cnt bipolar	
Current	1.28 µA/cnt	
Data format	Left justified, 16 bit 2s complement	
Conversion type	SAR	
Update rate	< 2 ms per enabled channel without 50 Hz/60 Hz rejection, < 8 ms for all channel 8 ms with 50 Hz/60 Hz rejection	
Step response time up to 63%	4...60 ms without 50Hz/60 Hz rejection – depends on number of enabled channel and filter setting 600 ms with 50 Hz/60 Hz rejection	
Input current terminal, user configurable	4...20 mA (default) 0...20 mA	
Input voltage terminal, user configurable	±10V 0...10V	

Input Specifications – 2085-IF4 and 2085-IF8

Attribute	2085-IF4	2085-IF8
Input impedance	Voltage terminal >1 M Ω Current terminal <100 Ω	
Absolute accuracy	\pm 0.10% Full Scale @ 25 ° C	
Accuracy drift with temp	Voltage terminal – 0.00428 % Full Scale/° C Current terminal – 0.00407 % Full Scale/° C	
Calibration required	Factory calibrated. No customer calibration supported.	
Overload, max.	30V continuous or 32 mA continuous, one channel at a time.	
Channel diagnostics	Over and under range or open circuit condition by bit reporting	

Output Specifications – 2085-OF4

Attribute	2085-OF4
Number of outputs	4
Resolution Voltage Current	12 bits unipolar; 11 bits plus sign bipolar 2.56 mV/cnt unipolar; 5.13 mV/cnt bipolar 5.13 μ A/cnt
Data format	Left justified, 16 bit 2s complement
Step response time up to 63%	2 ms
Conversion rate, max	2 ms per channel
Output current terminal, user configurable	0 mA output until module is configured 4...20 mA (default) 0...20 mA
Output voltage terminal, user configurable	\pm 10V 0...10V
Current load on voltage output, max	3 mA
Absolute accuracy Voltage terminal Current terminal	0.133 % Full Scale @ 25 ° C or better 0.425 % Full Scale @ 25 ° C or better
Accuracy drift with temp	Voltage terminal – 0.0045 % Full Scale/° C Current terminal – 0.0069 % Full Scale/° C
Resistive load on mA output	15...500 ohm @ 24V DC

Specialty Expansion I/O**2085-IRT4 Temperature Input Module**

Attribute	2085-IRT4
Number of inputs	4
Dimensions, HxWxD	44.5 x 90 x 87 mm (1.75 x 3.54 x 3.42 in.)
Shipping weight, approx.	220 g (7.76 oz)
Bus current draw, max	5V DC, 160 mA 24V DC, 50 mA

2085-IRT4 Temperature Input Module

Attribute	2085-IRT4
Wire size	0.25... 2.5 mm ² (22...14 AWG) solid or stranded copper wire rated @ 75 °C (167 °F), or greater, 1.2 mm (3/64 in.) insulation max
Wiring category ⁽¹⁾	2 – on signal ports
Terminal screw torque	0.5...0.6 Nm (4.4...5.3 lb-in.) ⁽²⁾
Input type	Thermocouple type: B, C, E, J, K, TXK/XK (L), N, R, S, T RTD type: 100 Ω Pt α = 0.00385 Euro 200 Ω Pt α = 0.00385 Euro 100 Ω Pt α = 0.003916 U.S. 200 Ω Pt α = 0.003916 U.S. 100 Ω Nickel 618 200 Ω Nickel 618 120 Ω Nickel 672 10 Ω Copper 427 mV range: 0...100 mV Ohm input: 0...500 Ω
Resolution	16 bits
Channel update time, typical	12...500 ms per enabled channel
Input impedance	> 10 M Ω
Accuracy	±0.5...±3.0 °C accuracy for Thermocouple inputs ±0.2...±0.6 °C accuracy for RTD inputs
Power dissipation, total	2 W
Enclosure type rating	Meets IP20
Status indicators	1 green health indicator
Isolation voltage	50V (continuous), Reinforced Insulation Type, channel to system. Type tested @ 720V DC for 60 s
North American temp code	T4

(1) Use this Conductor Category information for planning conductor routing. Refer to Industrial Automation Wiring and Grounding Guidelines, publication [1770-4.1](#).

(2) RTB hold down screws should be tightened by hand. They should not be tightened using a power tool.

*Environment Specifications***Environment Specifications for All Micro850 Expansion I/O Modules**

Attribute	Value
Temperature, operating	IEC60068-2-1 (Test Ad, Operating Cold), IEC60068-2-2, (Test Bd, Operating Dry Heat), IEC 60068-2-14 (Test Nb, Operating Thermal Shock): -20...65 °C (-4...149 °F)
Temperature, nonoperating	IEC 60068-2-1 (Test Ab, Unpackaged Nonoperating Cold), IEC 60068-2-2 (Test Bb, Unpackaged Nonoperating Dry Heat), IEC 60068-2-14 (Test Na, Unpackaged Nonoperating Thermal Shock): -40...85 °C (-40...185 °F)
Temperature, surrounding air, max.	65 °C (149 °F)
Relative humidity	IEC 60068-2-30 (Test Db, Unpackaged Damp Heat): 5...95% noncondensing
Vibration	IEC 60068-2-6 (Test Fc, Operating): 2 g @ 10...500 Hz

Environment Specifications for All Micro850 Expansion I/O Modules

Attribute	Value
Shock, operating	IEC 60068-2-27 (Test Ea, Unpackaged Shock): 25 g
Shock, nonoperating	IEC 60068-2-27 (Test Ea, Unpackaged Shock): 25 g for DIN Rail Mounting 35 g for Panel Mounting
Emissions	CISPR 11: Group 1, Class A
ESD Immunity	IEC 61000-4-2: 6 kV contact discharges 8 kV air discharges
Radiated RF Immunity	IEC 61000-4-3: 10V/m with 1 kHz sine-wave 80% AM from 80...2000 MHz 10V/m with 200 Hz 50% Pulse 100% AM @ 900 MHz 10V/m with 200 Hz 50% Pulse 100% AM @ 1890 MHz 10V/m with 1 kHz sine-wave 80% AM from 2000...2700 MHz
EFT/B Immunity	IEC 61000-4-4: ±2 kV @ 5 kHz on signal ports
Surge Transient Immunity	IEC 61000-4-5: ±1 kV line-line(DM) and ±2 kV line-earth(CM) on power ports ±2 kV line-earth(CM) on shielded ports
Conducted RF Immunity	IEC 61000-4-6: 10V rms with 1 kHz sine-wave 80% AM from 150 kHz...80 MHz

Certifications – All Micro800 Expansion I/O Modules

Certification (when product is marked) ⁽¹⁾	Value
c-UL-us	UL Listed Industrial Control Equipment, certified for US and Canada. See UL File E322657. UL Listed for Class I, Division 2 Group A,B,C,D Hazardous Locations, certified for U.S. and Canada. See UL File E334470
CE	European Union 2004/108/EC EMC Directive, compliant with: EN 61326-1; Meas./Control/Lab., Industrial Requirements EN 61000-6-2; Industrial Immunity EN 61000-6-4; Industrial Emissions EN 61131-2; Programmable Controllers (Clause 8, Zone A & B)
C-Tick	Australian Radiocommunications Act, compliant with: AS/NZS CISPR 11; Industrial Emissions
KC	Korean Registration of Broadcasting and Communications Equipment, compliant with: Article 58-2 of Radio Waves Act, Clause 3

(1) See the Product Certification link at <http://www.rockwellautomation.com/products/certification/> for Declaration of Conformity, Certificates, and other certification details.

Select Micro800 Plug-in Modules and Accessories



Micro800 plug-in modules extend the functionality of embedded I/O without increasing the footprint of the controller. It improves performance by adding additional processing power or capabilities and adds additional communication functionality. Micro820, Micro830 and Micro850 controllers support plug-in modules.

Micro800 accessories consist of a Remote LCD (compatible with Micro820 only), an LCD with keypad (compatible with Micro810 only), a USB adapter (compatible with Micro810 only), and an expansion power supply.

Micro800 Plug-in Modules and Accessories – Features and Compatibility

Plug-in / Accessory	Supported by Micro810	Supported by Micro820	Supported by Micro830/Micro850	Feature
1.5" LCD and Keypad 2080-LCD	Yes	No	No	<ul style="list-style-type: none"> • backup module for Micro810 controllers • configure Smart Relay Function Blocks
Micro810 USB Adapter 2080-USBADAPTER	Yes	No	No	USB programming access
External Power Supply 2080-PS120-240VAC	Yes	Yes	Yes	optional controller power supply
RS232/485 Isolated Serial Port 2080-SERIALISOL	No	Yes	Yes	<ul style="list-style-type: none"> • adds additional serial communications with Modbus RTU and ASCII protocols • isolated for increased noise immunity
Digital Input, Output, Relay, and Combination Modules 2080-IQ4, 2080-IQ4OB4, 2080-IQ4OV4, 2080-OB4, 2080-OV4, 2080-OW4I	No	Yes	Yes	<ul style="list-style-type: none"> • 4-channel inputs/outputs or combination modules • configurable as voltage and current inputs • sink or source output • 4-channel relay outputs
High Speed Counter 2080-MOT-HSC	No	Yes	Yes	<ul style="list-style-type: none"> • Up to a minimum of 250 KHz differential line driver for improved noise immunity and additional dedicated I/O • One Quadrature (ABZ) differential inputs alternately configurable for pulse internal, pulse with external direction, A-up and B-down input configurations, and quadrature mode • User-configurable minimum and maximum values, preset, and Z operation
DeviceNet Scanner 2080-DNET20	No	Yes	Yes	<ul style="list-style-type: none"> • Scanner mode – scan devices such as CompactBlock™ LDX, PowerFlex® drives, overloads and sensors
Remote LCD 2080-REMLCD	No	Yes	No	<ul style="list-style-type: none"> • Operator interface for configuring such settings as IP address on Micro820 controller • With RS232 and USB ports
Non-isolated Unipolar Analog Input/Output 2080-IF2, 2080-IF4, 2080-OF2	No	Yes	Yes	<ul style="list-style-type: none"> • adds up to 20 embedded analog I/O with 12-bit resolution (with 48-point controllers) • 2 channels for 2080-IF2, 2080-OF2 • 4 channels for 2080-IF4
Non-isolated Thermocouple 2080-TC2	No	Yes	Yes	<ul style="list-style-type: none"> • for temperature control, when used with PID
Non-isolated RTD 2080-RTD2	No	Yes	Yes	<ul style="list-style-type: none"> • 2 channels for 2080-TC2 and 2080-RTD2
Memory Module with RTC 2080-MEMBAK-RTC	No	No	Yes	<ul style="list-style-type: none"> • backup project data and application code • high accuracy real-time clock
6-Channel Trim Potentiometer Analog Input 2080-TRIMPOT6	No	Yes	Yes	adds six analog presets for speed, position and temperature control

Micro800 Plug-In Modules



Digital Input, Output, Relay, and Combination Plug-Ins



Specifications (2080-IQ4, 2080-IQ4OB4, 2080-IQ4OV4, 2080-OB4, 2080-OV4)

Catalog	Input / Output	On-state voltage	On-state current
2080-IQ4	4 inputs	DC 9.0V DC, min 30V DC, max AC 10.25V AC (rms), min 30V AC (rms), max	DC 2.0 mA @ 9V DC, min 3.0 mA @ 24V DC, nom 5.0 mA, max AC 2.0 mA @ 9V AC (rms), min 5.0 mA, max
2080-IQ4OB4	4 channel inputs/source outputs combination	DC Input 9.0V DC, min 30V DC, max AC Input 10.25V AC (rms), min 30V AC (rms), max	DC Input 2.0 mA @ 9V DC, min 3.0 mA @ 24V DC, nom 5.0 mA, max AC Input 2.0 mA @ 9V AC (rms), min 5.0 mA, max
2080-IQ4OV4	4 channel inputs/sink outputs combination	Output 10V DC, min 24V DC, nom 30V DC, max	Output 5.0 mA @ 10V DC, min 0.5 A max, steady state 2 A surge, 2 s min
2080-OB4	4 source outputs	10V DC, min 24V DC, nom 30V DC, max	5.0 mA @ 10V DC, min 0.5 A max, steady state 2 A surge, 2 s min
2080-OV4	4 sink outputs		

Specifications (2080-IQ4, 2080-IQ4OB4, 2080-IQ4OV4, 2080-OB4, 2080-OV4)

Catalog	Off-state voltage	Off-state current	Power supply voltage	Mounting torque	Status indicators	North American temp code
2080-IQ4	DC 5V DC, max AC 3.5V AC (rms)	DC 1.5 mA, max	10.8V DC, min 30V DC, max	0.2 Nm (1.48 lb-in.)	4 yellow	T4
2080-IQ4OB4					8 yellow	
2080-IQ4OV4					4 yellow	
2080-OB4, 2080-OV4	—	—				

Catalog	Terminal base screw torque	Isolation voltage	Wire size
2080-IQ4	0.22...0.25 Nm (1.95...2.21 lb-in.) using a 2.5 mm (0.10 in.) flat-blade screwdriver	50V (continuous), Basic Insulation Type, Inputs to Backplane Type tested for 60 s @ 720V DC, Inputs to Backplane	0.2... 2.5 mm ² (24...12 AWG) solid or stranded copper wire rated @ 90 °C (194 °F), or greater, insulation max
2080-IQ4OB4		50V (continuous), Basic Insulation Type, Inputs to Outputs, I/Os to Backplane Type tested for 60 s @ 720V DC, I/Os to Backplane	
2080-IQ4OV4			
2080-OB4			
2080-OV4			

Catalog	Operating temperature	Non-operating temperature	Surrounding air, max	Relative humidity	Vibration	Shock, operating	Shock, non-operating
2080-IQ4	-20...65 °C (-4...149 °F)	-40...85 °C (-40...185 °F)	65 °C (149 °F)	5...95% noncondensing	2 g @ 10...500 Hz	25 g	25 g
2080-IQ4OB4							
2080-IQ4OV4							
2080-OB4							
2080-OV4							

Specifications (2080-OW4I)

Catalog	Input/Output	Inrush current	Backplane power	Output current, resistive	Output current, inductive	Output power, resistive, max
2080-OW4I	4-channel relay output	<120 mA @ 3.3V <120 mA @ 24V	3.3 VDC, 38 mA	2 A @ 5...30V DC 0.5 A @ 48V DC 0.22 A @ 125V DC 2 A @ 125V AC 2 A @ 240V AC	1.0 A steady state @ 5...28V DC 0.93 A steady state @ 30V DC 0.5 A steady state @ 48V DC 0.22 A steady state @ 125V DC 2.0 A steady state, 15 A make @ 125V AC, PF – cos θ = 0.4 2.0 A steady state, 7.5 A make @ 240V AC, PF – cos θ = 0.4	250V A for 125V AC resistive loads 480V A for 240V AC resistive loads 60V A for 30V DC resistive loads 24V A for 48V DC resistive loads 27.5V A for 125V DC resistive loads

Catalog	Output power, inductive break, max	Pilot duty rating	Minimum load, per point	Initial contact resistance of relay, max	Output delay time, max
2080-OW4I	180 VA for 125V AC inductive loads 180 VA for 240V AC inductive loads 28 VA for 28.8V DC inductive loads 28 VA for 48V DC inductive loads 28 VA for 125V DC inductive loads	C300, R150	10 mA	30 mΩ	10 ms ON or OFF

Catalog	Relay contact, (0.35 power factor)					
	Volts, max	Amperes		Amperes Continuous	Volt-Amperes	
		Make	Break		Make	Break
2080-OW4I	120V AC	15 A	1.5 A	2.0 A	1800V A	180V A
	240V AC	7.5 A	0.75 A			
	24V DC	1.0 A		1.0 A	28V A	
	125V DC	0.22 A				

Catalog	Operating temperature	Non-operating temperature	Surrounding air, max	Relative humidity	Vibration	Shock, operating	Shock, non-operating
2080-OW4I	-20...65 °C (-4...149 °F)	-40...85 °C (-40...185 °F)	65 °C (149 °F)	5...95% noncondensing	2 g @ 10...500 Hz	10 g	DIN rail mounting: 25 g Panel mounting: 35 g

Analog Input and Output Plug-ins



Specifications (2080-IF2, 2080-IF4, 2080-OF2)

Catalog	Number of inputs/outputs	Voltage range	Current range	Power consumption	Input impedance	Voltage resistive load
2080-IF2	2 inputs, unipolar non-isolated	0...10V	0...20 mA	<60 mA @ 3.3V	>100 kΩ for voltage mode 250 Ω for current mode	
2080-IF4	4 inputs, unipolar non-isolated					
2080-OF2	2 outputs, unipolar non-isolated			<60 mA @ 24V	–	

Catalog	Current resistive load	Mounting torque	Terminal screw torque	Wire size	Operating temp.	Non-operating temp.	Surrounding air, max	North American temp code
2080-IF2	500 Ω	0.2 Nm (1.48 lb-in.)	0.22...0.25 Nm (1.95...2.21 lb-in.) using a 2.5 mm (0.10 in.) flat-blade screwdriver	Solid: 0.14 mm ² (26 AWG), min 1.5 mm ² (16 AWG), max Stranded: 0.14 mm ² (26 AWG), min 1.0 mm ² (18 AWG), max rated @ 90 °C (194 °F) insulation max	-20...65 °C (-4...149 °F)	-40...85 °C (-40...185 °F)	65 °C (149 °F)	T4
2080-IF4								
2080-OF2								



Thermocouple and RTD (2080-TC2, 2080-RTD2)

Specifications (2080-RTD2, 2080-TC2)

Catalog	Type	Common mode rejection ratio	Normal mode rejection ratio
2080-RTD2	2-channel non-isolated RTD	100 dB @ 50/60Hz	70 dB @ 50/60 Hz
2080-TC2	2-channel non-isolated Thermocouple		

Catalog	Type	Common mode rejection ratio	Normal mode rejection ratio	RTD types supported	Thermocouple types supported	Terminal screw torque
2080-RTD2	2-channel non-isolated RTD	100 dB @ 50/60Hz	70 dB @ 50/60 Hz	100 Ω Platinum 385, 200 Ω Platinum 385, 500 Ω Platinum 385, 1000 Platinum 385, 100 Ω Platinum 392, 200 Ω Platinum 392, 500 Ω Platinum 392, 1000 Ω Platinum 392, 10 Ω Copper 427, 120 Ω Nickel 672, 604 Ω Nickel-Iron 518	–	0.22...0.25 Nm (1.95...2.21 lb-in.) using a 2.5 mm (0.10 in.) flat-blade screwdriver
2080-TC2	2-channel non-isolated Thermocouple			–	J, K, N, T, E, R, S, B	

Catalog	Wire size	Operating temperature	Non-operating temperature	Surrounding air, max	North American temp code
2080-RTD2	Solid: 0.14 mm ² (26 AWG), min 1.5 mm ² (16 AWG), max Stranded: 0.14 mm ² (26 AWG), min 1.0 mm ² (18 AWG), max rated @ 90 °C (194 °F) insulation max	-20...65 °C (-4...149 °F)	-40...85 °C (-40...185 °F)	65 °C (149 °F)	T4
2080-TC2					



Trimpot Analog Input (2080-TRIMPOT6)

Specifications (2080-TRIMPOT6)

Number of inputs	Mounting torque	Operating temperature	Non-operating temperature	Surrounding air, max	North American temp code
6-channel, Trimpot	0.2 Nm (1.48 lb-in.)	-20...65 °C (-4...149 °F)	-40...85 °C (-40...185 °F)	65 °C (149 °F)	T4



Memory Backup and High Accuracy RTC Plug-In (2080-MEMBAK-RTC)

Specifications (2080-MEMBAK-RTC)

Mounting torque	Terminal screw torque	Operating temperature	Non-operating temperature	Surrounding air, max	North American temp code
0.2 Nm (1.48 lb-in)	0.22...0.25 Nm (1.95...2.21 lb-in.) using a 2.5 mm (0.10 in.) flat-blade screwdriver	-20...65 °C (-4...149 °F)	-40...85 °C (-40...185 °F)	65 °C (149 °F)	T4



RS232/485 Serial Port Plug-in (2080-SERIALISOL)

Specifications (2080-SERIALISOL)

Mounting torque	Terminal screw torque	Wire size	Isolation voltage
0.2 Nm (1.48 lb-in)	0.22...0.25 Nm (1.95...2.21 lb-in) using a 2.5 mm (0.10 in.) flat-blade screwdriver	Solid: 0.14...1.5 mm ² (26...16 AWG) Stranded: 0.14...1.0 mm ² (26...18 AWG) rated @ 90 °C (194 °F) insulation max	500V AC

Operating temperature	Non-operating temperature	Surrounding air, max	North American temp code
-20...65 °C (-4...149 °F)	-40...85 °C (-40...185 °F)	65 °C (149 °F)	T4



DeviceNet (2080-DNET20)

Specifications (2080-DNET20)

DeviceNet Communication Rate, max	DeviceNet current	Wire size
125 Kbps – 420 m (1378 ft.) 250 Kbps – 200 m (656 ft.) 500 Kbps – 75 m (246 ft.)	24V DC, 300 mA Class 2	0.25... 2.5 mm ² (22...14 AWG) solid or stranded copper wire rated @ 75 °C (167 °F), or greater, 1.2 mm (3/64 in.) insulation max

Network protocol	Backplane power consumption	Power dissipation	Number of nodes, max
I/O Slave Messaging: Poll Command	50 mA @ 24V DC	1.44 W	20 nodes for I/O operation



High Speed Counter (2080-MOT-HSC)

Specifications (2080-MOT-HSC)

Input Frequency, max	Wire size	Number of inputs
250 kHz (50% duty)	Solid: 0.14...1.5 mm ² (26...16 AWG) Stranded: 0.14...1.0 mm ² (26...18 AWG) rated @ 90 °C (194 °F) insulation max	1 Quadrature (ABZ) differential input

Input impedance	Pulse width, min	All supply power and/or current ratings	Isolation voltage
3580 Ω	2 μs	Input/Output: 24V DC	Input module: 50V (continuous), Basic Insulation Type, Inputs/Outputs to Backplane. Type tested for 60s @ 720V DC, Inputs/Outputs to Backplane

Micro800 Accessories

Micro810 LCD (2080-LCD)

Operating temperature	Temperature, surrounding air, max	Temperature, nonoperating	North American temp code
-20...55 °C (-4...131 °F)	55 °C (131 °F)	-40...85 °C (-40...185 °F)	T5

Micro810 USB Adapter (2080-USBADAPTER)

USB cable connector type	Temperature, operating	Temperature, surrounding air, max	Temperature, non-operating	North American temp code
USB Type A-B Male-Male	-20...55 °C (-4...131 °F)	55 °C (131 °F)	-40...85 °C (-40...185 °F)	T5

External Power Supply (2080-PS120-240VAC)

Attribute	Value
Dimensions, HxWxD	90 x 45 x 80 mm (3.55 x 1.78 x 3.15 in)
Shipping weight	0.34 kg (0.75 lb)
Supply voltage range ⁽¹⁾	100V...120V AC, 1A 200...240V AC, 0.5A
Supply frequency	47...63 Hz
Supply power	24V DC, 1.6 A
Inrush current, max	24 A @ 132V for 10 ms 40 A @ 263V for 10 ms
Power consumption ⁽²⁾ (Output power)	38.4 W @ 100V AC, 38.4 W @ 240V AC
Power dissipation (Input power)	45.1 W @ 100V AC, 44.0W @ 240V AC
Isolation voltage	250V (continuous), Primary to Secondary: Reinforced Insulation Type Type tested for 60s @ 2300V AC primary to secondary and 1480V AC primary to earth ground.
Output ratings	24V DC, 1.6 A, 38.4 W max.

(1) Any fluctuation in voltage source must be within 85V...264V. Do not connect the adapter to a power source that has fluctuations outside of this range.

(2) When setting up a Micro800 system, verify that total power consumption of the controller, plug-in and expansion I/O does not exceed the output power capacity of the power supply used.

Remote LCD (2080-REMLCD)

Attribute	Value
Dimensions, HxWxD	97 x 130 x 35.5 mm (3.82 x 5.12 x 1.40 in.)
Display type	192 x 64 pixel monochrome
Display size	48 x 106.5 mm (1.89 x 4.19 in.)
Backlight	25000 hrs @ 25 °C LED; tricolor backlight (RGB)
Operator input	Tactile keys (function keys, arrow keys, ESC and OK keys)
Programming port	USB to serial converter for programming the controller
Input supply voltage	12V/24V DC (±10%)
Input supply current, max	90 mA @ 12V and 60 mA @ 24V
Power consumption, max	1.5 W
Weight, approx.	405 g (0.89 lb) – includes packaging weight
Wire size	Single-wire gauge: 0.14...1.5 mm ² (26...16 AWG) rated @ 90 °C (194 °F) Dual-wire gauge: 0.14...0.75 mm ² (26...18 AWG) rated @ 90 °C (194 °F)
Wire type	Copper
Wiring category ⁽¹⁾	3 – on power ports; 3 – on communication port
Enclosure type ratings	Meets IP65 (when front panel mounted)
North American temp code	T4

(1) Use this conductor category information.

For More Information

Visit the Micro800 website at <http://ab.rockwellautomation.com/Programmable-Controllers/Micro800> to learn more about Micro800 products and download Connected Component Workbench software and Micro800 firmware updates.

If you would like a manual, you can:

- download a free electronic version from the Internet: <http://rockwellautomation.com/literature>.
- purchase a printed manual by contacting your local Allen-Bradley distributor or Rockwell Automation representative.

You can also visit the following websites for additional technical information:

- **Sample Code Library**
http://samplecode.rockwellautomation.com/idc/groups/public/documents/webassets/sc_home_page.hcst
- **Technical Forums**
<http://www.rockwellautomation.com/forums/>
- **Connected Component Accelerator Toolkit**
<http://www.rockwellautomation.com/components/connected/ccat.html>

Additional Resources

These documents contain additional information concerning related Rockwell Automation products.

Resource	Description
Micro810 Programmable Controllers User Manual, publication 2080-UM001	A more detailed description of how to install and use your Micro810 programmable controller.
Micro820 Programmable Controllers User Manual, publication 2080-UM005	A more detailed description of how to install and use your Micro820 programmable controllers.
Micro830 and Micro850 Programmable Controllers User Manual, publication 2080-UM002	A more detailed description of how to install and use your Micro830 and Micro850 programmable controller.
Micro800 Plug-in Modules User Manual, publication 2080-UM004	Description of features, installation, wiring, and specifications for the Micro800 plug-in modules.
Micro800 Discrete and Analog Expansion I/O Modules User Manual, publication 2080-UM003	Description of features, installation, wiring, and specifications for the Micro800 expansion I/O modules and accessories.
Industrial Automation Wiring and Grounding Guidelines, publication 1770-4.1	Provides general guidelines for installing a Rockwell Automation industrial system.
Product Certifications website, http://www.rockwellautomation.com/products/certification/	Provides declarations of conformity, certificates, and other certification details.

Rockwell Automation Support

Rockwell Automation provides technical information on the Web to assist you in using its products.

At <http://www.rockwellautomation.com/support/>, you can find technical manuals, a knowledge base of FAQs, technical and application notes, sample code and links to software service packs, and a MySupport feature that you can customize to make the best use of these tools.

For an additional level of technical phone support for installation, configuration, and troubleshooting, we offer TechConnect support programs. For more information, contact your local distributor or Rockwell Automation representative, or visit <http://www.rockwellautomation.com/support/>.

Installation Assistance

If you experience a problem within the first 24 hours of installation, review the information that is contained in this manual. You can contact Customer Support for initial help in getting your product up and running.

United States or Canada	1.440.646.3434
Outside United States or Canada	Use the Worldwide Locator at http://www.rockwellautomation.com/support/americas/phone_en.html , or contact your local Rockwell Automation representative.

New Product Satisfaction Return

Rockwell Automation tests all of its products to ensure that they are fully operational when shipped from the manufacturing facility. However, if your product is not functioning and needs to be returned, follow these procedures.

United States	Contact your distributor. You must provide a Customer Support case number (call the phone number above to obtain one) to your distributor to complete the return process.
Outside United States	Please contact your local Rockwell Automation representative for the return procedure.

Documentation Feedback

Your comments will help us serve your documentation needs better. If you have any suggestions on how to improve this document, complete this form, publication [RA-DU002](#), available at <http://www.rockwellautomation.com/literature/>.

Rockwell Otomasyon Ticaret A.Ş., Kar Plaza İş Merkezi E Blok Kat:6 34752 İçerenköy, İstanbul, Tel: +90 (216) 5698400

www.rockwellautomation.com

Power, Control and Information Solutions Headquarters

Americas: Rockwell Automation, 1201 South Second Street, Milwaukee, WI 53204-2496 USA, Tel: (1) 414.382.2000, Fax: (1) 414.382.4444

Europe/Middle East/Africa: Rockwell Automation NV, Pegasus Park, De Kleetlaan 12a, 1831 Diegem, Belgium, Tel: (32) 2 663 0600, Fax: (32) 2 663 0640

Asia Pacific: Rockwell Automation, Level 14, Core F, Cyberport 3, 100 Cyberport Road, Hong Kong, Tel: (852) 2887 4788, Fax: (852) 2508 1846

Publication 2080-SG001D-EN-P - December 2013

Supersedes Publication 2080-SG001C-EN-P – September 2012

Copyright © 2013 Rockwell Automation, Inc. All rights reserved. Printed in the U.S.A.